





Contents

Basic Operation	3	REVERB	26
Basic Procedure for Effect Editing	3	PEDAL FX	27
Effect Placement	3	FOOT VOLUME	27
Using STOMPBOX	4	DIVIDER 1–3	28
Editing the STOMPBOX	4	MIXER 1–3	28
Reading STOMPBOX Settings into a Patch	4	SEND/RETURN 1, 2	29
Writing Patch Settings into a STOMPBOX	4	OUTPUT SP.SIMULATOR L, OUTPUT SP.SIMULATOR R, SUB OUT SP.SIMULATOR L, SUB OUT SP.SIMULATOR R	30
Basic MENU Operations	5	MASTER	31
Effect	6	MENU	32
COMPRESSOR	6	CONTROL MODE	32
DISTORTION 1, 2	6	CONTROL ASSIGN	32
AIRD PREAMP 1, 2	7	CONTROL FUNCTION	32
NOISE SUPPRESSOR 1, 2	8	ASSIGN SETTING	33
EQUALIZER 1–4	9	Virtual Expression Pedal (Internal Pedal / Wave Pedal)	42
DELAY 1–4	9	INPUT (Input Level)	42
MASTER DELAY	10	INPUT SENS (Input Sens)	42
CHORUS	12	PATCH MIDI	43
FX1–FX3	13	LED COLOR	43
AC.G SIM (AC. GUITAR SIMULATOR)	14	TEMPO HOLD	43
AC RESO (AC RESONANCE)	14	IN/OUT SETTING	44
AUTO WAH	14	INPUT	44
CHORUS	15	OUTPUT, SUB OUT	44
CHO BASS (CHORUS BASS)	16	TOTAL	45
C-VIBE (CLASSIC VIBE)	17	USB-Related Settings	46
COMP (COMPRESSOR)	17	PLAY OPTION	47
DEFRETR (DEFRETTER)	17	MIDI	47
DEFRET B (DEFRETTER BASS)	17	MIDI SETTING	47
DIST (DISTORTION)	17	PROGRAM MAP BANK1–BANK4	48
FEEDBAKR (FEEDBACKER)	18	BULK DUMP	48
FLANGER/FLANGR B (FLANGER B)	19	HARDWARE SETTING	49
HARMONST (HARMONIST)	19	KNOB	49
HUMANIZR (HUMANIZER)	20	AMP CONTROL	54
MST.FX (MASTERING FX)	21	EXP HOLD	54
OCTAVE	21	GROUND LIFT	54
OCT BASS (OCTAVE BASS)	21	OTHER	54
OVERTONE	21	AUTO OFF	54
PAN	22	FACTORY RESET	55
PHASER	22	TUNER	55
PITCH SFT (PITCH SHIFTER)	23	METRONOME	55
RING MOD	23	Saving a Sound (WRITE)	56
ROTARY	24	Saving a Patch (PATCH WRITE)	56
SITAR SIM	24	Exchanging Patches (PATCH EXCHANGE)	56
SLICER	24	Initializing Patches (PATCH INITIALIZE)	57
SLW GEAR (SLOW GEAR)/ SG BASS (SLOW GEAR BASS)	24	Inserting a Patch (PATCH INSERT)	57
SND HOLD (SOUND HOLD)	24		
S-BEND	25		
TOUCH WH (TOUCH WAH)/ TW BASS (TOUCH WAH BASS)	25		
TREMOLO	25		
VIBRATO	25		

MEMO

-  This effect sound is mono.
-  This effect sound is output with two channels.
-  These effects take a mono input and output it on two channels.

* Company names and product names appearing in this document are registered trademarks or trademarks of their respective owners.

Copyright © 2020 ROLAND CORPORATION

Basic Operation

Basic Procedure for Effect Editing

The edit screens show the block configuration (effect chain) of all effects provided by the GT-1000CORE, as well as the output and send/return. You can edit from this effect chain display by selecting the block that you want to edit.

1. Press the [EFFECT] button.

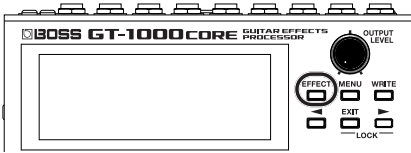

The edit screen (effect chain) appears.

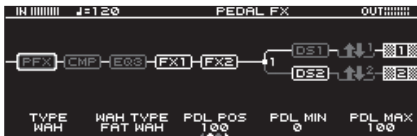

2. Turn knob [6] to select the block that you want to edit.

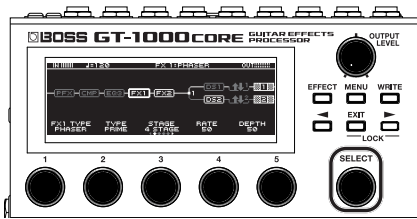

The selected block is enclosed by a thick frame.



* By pressing knob [SELECT] you can turn the selected effect on/off. Effects that are off are shown in gray. When the effect is turned on, it is shown in white.

Off On



3. Use knobs [1]–[5] to adjust the parameters that are shown below the screen.

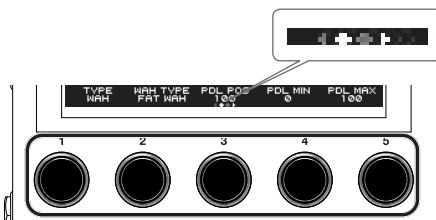

Use the PAGE [◀] [▶] buttons to switch between the parameters that you want to edit. The current page is indicated in the lower center of the screen.

- * To change a value in larger steps, turn a knob while pressing it.
- * The number of parameters and pages differs depending on the effect.

Editing while viewing all parameters

From the edit screen, you can long-press knob [SELECT] to see a list of all parameters of the selected block. You can edit the parameters from this list.

FX1 TYPE		FX 1: PHASER		SEL: OFF/ON	
PHASER	PRIME	4 STAGE	RATE	50	
RESON	MANUAL	WAVEFORM	STEP	BI-PHASE	
0	50	TRI	OFF	OFF	
SEPARATE	LO DAMP	HI DAMP	LO CUT	HI CUT	
0	-50	-50	FLAT	FLAT	

1. Turn the [SELECT] knob to select the item that you want to set.

Turning the knob will move the selected item vertically.

2. Turn knobs [1]–[6] to edit the value of the parameters shown in the screen.

Use the PAGE [◀] [▶] buttons to switch between lists of parameters.

FX1 TYPE		FX 1: PHASER		SEL: OFF/ON	
E LEVEL	DIR MIX			STOMPBOX	
100	0			-----	

Effect Placement

By moving blocks such as effects, output, and send/return, you can freely change the order in which the effects are placed, or arrange them in parallel.



Changing the placement of effects etc.

1. Press the [EFFECT] button.

The effect chain is shown.

2. Use knob [SELECT] to select the block that you want to move.

3. While pressing knob [SELECT], turn it left or right.

The selected block moves left or right.

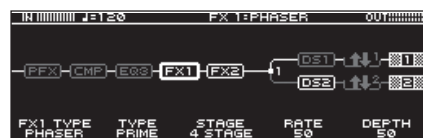

Using STOMPBOX

Your preferred settings for each effect can be saved as a “STOMPBOX.”

You can select these saved settings and use them to create your sound just as though you were connecting compact pedal effects. The STOMPBOX data is common to all patches; this means that all patches using the same STOMPBOX can be edited simultaneously.

1. Press the [EFFECT] button.
2. Use the [SELECT] knob to choose the effect you’re going to edit.

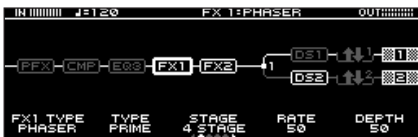

3. Use the PAGE [◀] [▶] buttons to move to the last page.

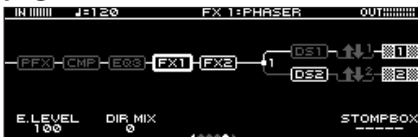

4. Press the [5] knob.

The STOMPBOX select window appears.



5. Turn knob [SELECT] to select the STOMPBOX type.
6. Press the [SELECT] knob.

Editing the STOMPBOX

1. Turn knobs [1]–[5] to edit the parameter value that are shown in the screen.

Use the PAGE [◀] [▶] buttons to switch between lists of parameters.

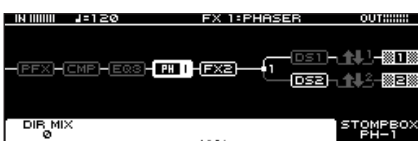
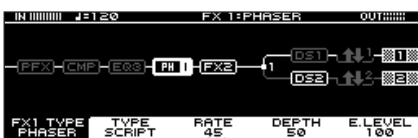

Reading STOMPBOX Settings into a Patch

1. Press the [EFFECT] button.
2. Use the [SELECT] knob to choose the effect you’re going to edit.

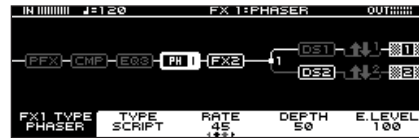

3. Use the PAGE [◀] [▶] buttons to move to the last page.



4. Press the [5] knob.

The STOMPBOX select window appears.



5. Turn knob [SELECT] to select the STOMPBOX type.
6. Press the [5] (STOMPBOX COPY) knob.

The contents of the STOMPBOX are recalled into the patch.

You can edit the patch without modifying the contents of the STOMPBOX.

Writing Patch Settings into a STOMPBOX

1. Press the [EFFECT] button.
2. Use the [SELECT] knob to choose the effect you’re going to save.



3. Use the PAGE [◀] [▶] buttons to move to the last page.



4. Press the [5] knob.

The STOMPBOX select window appears.



5. Press the [4] (WRITE TO STOMPBOX) knob.



6. Turn knob [1] to select the writing-destination STOMPBOX.

7. Use knobs [3]–[5] and [SELECT] knob to name the STOMPBOX.

You can turn the [SELECT] knob to move the cursor within the name.

Reference

For details on naming the STOMPBOX, refer to “Editing a name” (p. 56).

Basic MENU Operations

Here you can make settings that are common to the entire GT-1000CORE (system parameters).

1. Press the [MENU] button.

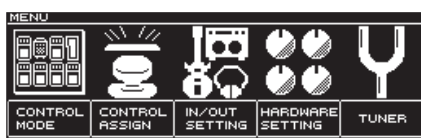
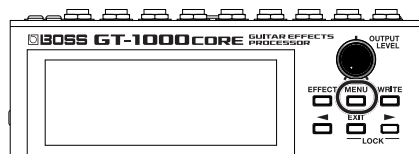

* You can use the PAGE [◀] [▶] buttons to see additional items.

2. Press a knob [1]–[5] to select the item that you want to edit.

A sub-menu appears.



3. Once again press a knob [1]–[5] to select the item that you want to edit.

4. Use knobs [1]–[5] and [SELECT] knob to select parameters or edit the values.







Effect

- * Company names and product names appearing in this document are registered trademarks or trademarks of their respective owners.
- * In this manual, company names and product names of the respective owners are used because it is the most practical way of describing the sounds that are emulated using DSP technology.

COMPRESSOR

STEREO

This is an effect that produces a long sustain by evening out the volume level of the input signal.

Parameter	Value	Explanation
ON/OFF	OFF, ON	Turns this effect on/off.
TYPE	BOSS CMP (BOSS COMP) 	This models a BOSS CS-3.
	X-COMP 	This uses MDP (Multi-Dimensional Processing) to obtain a consistently natural playing feel and sound that responds to the pitch range and dynamics of your phrase.
	D-COMP 	This models a MXR DynaComp.
	ORANGE 	This is modeled on the sound of the Dan Armstrong ORANGE SQUEEZER.
	STEREO 	This selects a stereo compressor.
	X-BASS 	This is a compressor for bass that uses MDP (Multi-Dimensional Processing).
THRESHLD *1	0-100	Adjust this as appropriate for the input signal. When the input signal level exceeds this threshold level, compression will be applied.
SUSTAIN *2	0-100	Adjusts the range (time) over which low-level signals are boosted. Larger values will result in longer sustain.
ATTACK	0-100	Adjusts the strength of the attack when picking.
LEVEL	0-100	Adjusts the volume.
TONE	-50-+50	Adjusts the tone.
RATIO	1:1-INF:1	Selects the compression ratio.
DIR MIX	0-100	Adjusts the volume of the direct sound.

*1 Setting available when TYPE is set to X-BASS.

*2 Not shown if TYPE is set to X-BASS.

DISTORTION 1, 2

MONO

This effect distorts the sound to create long sustain.

Parameter	Value	Explanation
ON/OFF	OFF, ON	Turns this effect on/off.
TYPE	Refer to "DISTORTION 1, 2 TYPE" (p. 6)	
DRIVE	0-120	Adjusts the depth of distortion.
TONE	-50-+50	Adjusts the tone.
LEVEL	0-100	Adjusts the volume of the effect sound.
BOTTOM	-50-+50	Adjusts the tone for the low frequency range. Turning this to the left (counterclockwise) produces a sound with the low end cut; turning it to the right boosts the low end in the sound.
DIR MIX	0-100	Adjusts the volume of the direct sound.
SOLO SW	OFF, ON	The tone to one suitable for solos.
SOLO LVL (SOLO LEVEL)	0-100	Adjusts the volume level when the SOLO SW is ON.

DISTORTION 1, 2 TYPE

This is a list of distortion types that can be selected for DISTORTION 1, 2

Type	Explanation
MID (MID BOOST)	This is a booster with unique characteristics in the midrange. Making the connection before the AIRD PREAMP produces sound suitable for solos.
CLEAN (CLEAN BOOST)	This not only functions as a booster, but also produces a clean tone that has punch even when used alone.
TREBLE (TREBLE BOOST)	This is a booster that has bright characteristics.
CRUNCH	A lustrous crunch sound with an added element of amp distortion.
NATURAL (NATURAL OD)	This is an overdrive sound that provides distortion with a natural feeling.
WARM OD	This is a warm overdrive.
FAT DS	A distortion sound with thick distortion.
LEAD DS	Produces a distortion sound with both the smoothness of an overdrive along with a deep distortion.
METAL DS	This is a distortion sound that is ideal for performances of heavy riffs.
OCT FUZZ	A fuzz sound with rich harmonic content.
A-DIST	This uses MDP technology to obtain ideal distortion in all ranges of the guitar, from low to high.
X-OD	This is an overdrive that uses MDP to obtain the distortion that's most appropriate in each pitch range.
X-DIST	This is a distortion that uses MDP to obtain the distortion that's most appropriate in each pitch range.
BLUES OD	This is a crunch sound of the BOSS BD-2. This produces distortion that faithfully reproduces the nuances of picking.
OD-1	This models the sound of the BOSS OD-1. This produces sweet, mild distortion.
SD-1	This models the sound of the BOSS SD-1.
T-SCREAM	This models an Ibanez TS-808.
TURBO OD	This is the high-gain overdrive sound of the BOSS OD-2.
DIST	This gives a basic, traditional distortion sound.
DS-1	This models the sound of the BOSS DS-1.
CENTA OD	This models a KLON CENTAUR.
RAT	This models a Proco RAT.
GUV DS	This models a Marshall GUV' NOR.
DIST+	This models the sound of the MXR DISTORTION+.

Type	Explanation
MTL ZONE (METAL ZONE)	This models the sound of the BOSS MT-2. It produces a wide range of metal sounds, from old style to slash metal.
HM-2	This models the sound of the BOSS HM-2. It produces distinctive cranked-up distortion sound with compression.
MTL CORE (METAL CORE)	This is the sound of the BOSS ML-2 which is ideal for high speed metal riffs.
60S FUZZ	This models a FUZZFACE. It produces a fat fuzz sound.
MUFF FUZ (MUFF FUZZ)	This models an Electro-Harmonix Big Muff π.
BASS OD	Overdrive tuned especially for use with basses.
BASS DS	Distortion tuned especially for use with basses.
BASS MT	Wild, radical distortion sound.
BASS FUZZ	Fuzz tuned especially for use with basses.
HI BAND	With this effect, distortion is applied only to the high frequency sounds, and not to the sounds in the low frequency range.
X-BASS	This effect uses MDP to provide ideal distortion in all pitch ranges of the bass, from low to high.
BASS DRV	This models a TECH21 SANSAMP BASS DRIVER DI.
BASS DI	This models a MXR Bass D.I.+.

* Company names and product names appearing in this document are registered trademarks or trademarks of their respective owners.

* In this manual, company names and product names of the respective owners are used because it is the most practical way of describing the sounds that are emulated using DSP technology.

AIRD PREAMP 1, 2

MONO

This is an amp that uses BOSS's proprietary cutting-edge AIRD (Augmented Impulse Response Dynamics) technology to simulate every detail of a guitar amp as a unified instrument, including the response and operation of the guitar amp's circuit and the interactions between all parts that affect the sound.

Parameter	Value	Explanation
ON/OFF	OFF, ON	Turns this effect on/off.
TYPE	Refer to "AIRD PREAMP TYPE List" (p. 8)	
GAIN	0–120	Adjusts the distortion of the amp.
SAG	-10–+10	Adjusts the amount by which compression changes in response to the power amp.
RESO (RESONANCE)	-10–+10	Adjusts the amount by which dynamics is affected by the interaction between the power amp and the speaker transformer.
LEVEL	0–100	Adjusts the volume of the entire preamp. * Be careful not to raise the Level setting too high.
BASS	0–100	Adjusts the tone for the low frequency range.
MIDDLE	0–100	Adjusts the tone for the middle frequency range.
TREBLE	0–100	Adjusts the tone for the high frequency range.
PRESENCE	0–100	Adjusts the tone for the ultra high frequency range.
BRIGHT	OFF, ON	Turns the bright setting on/off. * The BRIGHT setting is available only when certain AIRD PREAMP TYPE settings are selected.
GAIN SW	LOW, MIDDLE, HIGH	Provides for selection from three levels of distortion: LOW, MIDDLE, and HIGH. Distortion will successively increase for settings of LOW, MIDDLE and HIGH. * The sound of each Type is created on the basis that the Gain is set to MIDDLE. So, normally set it to MIDDLE.
SOLO SW	OFF, ON	The tone to one suitable for solos.
SOLO LVL (SOLO LEVEL)	0–100	Adjusts the volume level when the SOLO SW is ON.

AIRD PREAMP TYPE List

Category	Type	Explanation
TYPE (ADVANCED AMP)	TRNSPRNT (TRANSPARENT)	An amp with a broad frequency range and an extremely flat response. Good for acoustic guitar.
	NATURAL	An unembellished, clean sound that minimizes the amp's idiosyncrasies, such as its trebly character and boomy low end.
	BOUTIQUE	Crunch sound that allows the nuances of your picking to be expressed even more faithfully than on conventional combo amps.
	SUPREME	Great-feeling crunch sound that responds to the nuances of your picking while taking advantage of the distinctive character of a 4x12" speaker cabinet.
	MAXIMUM	An amp that delivers the distinctively great response and tone of a vintage Marshall, while making it even higher gain.
	JUGGERNT (JUGGERNAUT)	A large stack sound that has been tweaked extensively in the pursuit of the ultimate metal sound.
	X-CRUNCH	Crunch sound that uses MDP to deliver a crisp tone from all strings.
	X-HI GAIN	High-gain sound that uses MDP to obtain high-gain sound with a wide range and a great-feeling sense of separation.
	X-MODDED	Core sound that uses MDP to preserve the definition of the sound even with extreme gain.
	X-ULTRA	A high-gain sound that uses MDP for a dense midrange tone with dynamics.
	X-OPTIMA	A high-gain sound that uses MDP to emphasize sonic balance for phrases and ensemble playing.
	X-TITAN	A tight high-gain sound with an edge, which uses MDP.
	TYPE (CLASSICS)	JC-120
TWIN (TWIN COMBO)		This models a Fender Twin Reverb.
DELUXE (DELUXE COMBO)		This models a Fender Deluxe Reverb.
TWEED (TWEED COMBO)		This models a Fender Bassman 4 x 10" Combo.
DIAMOND (DIAMOND AMP)		This models a VOX AC30.
BRIT STK (BRIT STACK)		This models a Marshall 1959.
RECTI STK (RECTI STACK)		Models the sound of the Channel 2 MODERN Mode on the MESA/Boogie DUAL Rectifier.
MATCH (MATCH COMBO)		This models the sound input to left input on a Matchless D/C-30.
BG COMBO		This models the sound of the MESA/Boogie combo amp.
ORNG STK (ORNG STACK)		This models the dirty channel of an ORANGE ROCKERVERB.
BGMR UB (BGMR UB METAL)		This models the sound that models the high-gain channel of a Bogner Uberschall.
TYPE (ADVANCED AMP)		NATRL BS (NATURAL BASS)
	X-DRV BS (X-DRIVE BASS)	High-gain sound for bass, using MDP to provide wide range and a good-sounding sense of separation.

Category	Type	Explanation
TYPE (CLASSICS)	CONCERT	This models the Ampeg SVT.
	STUDIO BS (STUDIO BASS)	This models the Markbass Little Mark III.
	SILVER (SILVER TUBE)	This models a Fender Bassman 100.
	CL BLUE (CLASSIC BLUE)	This models the Acoustic 360.
	SOLID STK (SOLID STACK)	This models the Gallien-Krueger 800RB.
	FAT TUBE	This models the Orange AD200B MKIII.
	DARK DRV	This models the Darkglass Electronics MICROTUBES B7K.

* Company names and product names appearing in this document are registered trademarks or trademarks of their respective owners.

* In this manual, company names and product names of the respective owners are used because it is the most practical way of describing the sounds that are emulated using DSP technology.

NOISE SUPPRESSOR 1, 2

STEREO

This effect reduces the noise and hum picked up by guitar pickups. Since it suppresses the noise in synchronization with the envelope of the guitar sound (the way in which the guitar sound decays over time), it has very little effect on the guitar sound, and does not harm the natural character of the sound.

Parameter	Value	Explanation
ON/OFF	OFF, ON	Turns this effect on/off.
THRESHLD (THRESHOLD)	0-100	Adjust this parameter as appropriate for the volume of the noise. If the noise level is high, a higher setting is appropriate. If the noise level is low, a lower setting is appropriate. Adjust this value until the decay of the guitar sound is as natural as possible. * High settings for the threshold parameter may result in there being no sound when you play with your guitar volume turned down.
RELEASE	0-100	Adjusts the time from when the noise suppressor begins to function until the noise level reaches "0."
DETECT	This controls the noise suppressor based on the volume level for the point specified in Detect.	
	INPUT	Input volume from input jack. * Ordinarily, DETECT should be set to "INPUT."
	NS INPUT	Noise suppressor input volume. * When connected as illustrated below, and you want to prevent a spatial-type effects sound (such as a delay sound) from being eradicated by the NS, you should set DETECT to "NS INPUT." (Spatial-type effect)
FV OUT	Volume after passing through Foot Volume. * If you want to use FV (Foot Volume) in place of the guitar's volume control, you need to set DETECT to "FV OUT." Foot Volume	

EQUALIZER 1–4

STEREO

Adjusts the tone.

Parameter	Value	Explanation
ON/OFF	OFF, ON	Turns this effect on/off.
TYPE	PARAMTRC (PARAMETRIC)	You can adjust the tone character in four bands.
	GRAPHIC	You can adjust the tone character in ten bands.

PARAMETRIC

Adjusts the tonal quality. You can adjust the tone character in four bands.

Parameter	Value	Explanation
LO GAIN	-20+20dB	Adjusts the tone for the low frequency range.
HI GAIN	-20+20dB	Adjusts the tone for the high frequency range.
LEVEL	-20+20dB	Adjusts the overall volume level of the equalizer.
LM FREQ	20.0Hz–16.0kHz	Specifies the center of the frequency range that will be adjusted by the LM GAIN.
LM Q	0.5–16	Adjusts the width of the area affected by the EQ centered at the LM FREQ. Higher values will narrow the area.
LM GAIN	-20+20dB	Adjusts the low-middle frequency range tone.
HM FREQ	20.0Hz–16.0kHz	Specifies the center of the frequency range that will be adjusted by the HM GAIN.
HM Q	0.5–16	Adjusts the width of the area affected by the EQ centered at the HM FREQ. Higher values will narrow the area.
HM GAIN	-20+20dB	Adjusts the low-middle frequency range tone.
LO CUT	FLAT, 20.0Hz–20.0kHz	This sets the frequency at which the low cut filter begins to take effect. When FLAT is selected, the low cut filter will have no effect.
HI CUT	20.0Hz–20.0kHz FLAT	This sets the frequency at which the high cut filter begins to take effect. When FLAT is selected, the high cut filter will have no effect.

GRAPHIC

Adjusts the tonal quality. You can adjust the tone character in ten bands.

Parameter	Value	Explanation
LEVEL	-20+20dB	Adjusts the overall volume level of the equalizer.
31.5Hz	-20+20dB	Adjust the volume of each frequency band.
63Hz		
125Hz		
250 Hz		
500 Hz		
1 kHz		
2 kHz		
4 kHz		
8 kHz		
16 kHz		

DELAY 1–4

STEREO

This is a delay with a maximum delay time of 2,000 ms. This effect is a useful way of adding depth to the sound.

Parameter	Value	Explanation
ON/OFF	OFF, ON	Turns this effect on/off.
TIME	1ms–2000ms, BPM $\frac{1}{4}$ –16	Adjusts the delay time. * When set to BPM, the value of each parameter will be set according to the value of the “MASTER BPM” specified for each patch. This makes it easier to achieve effect sound settings that match the tempo of the song. * If, due to the tempo, the time is longer than the range of allowable settings, it is then synchronized to a period either 1/2 or 1/4 of that time.
FEEDBACK	0–100	Adjusts the volume that is returned to the input. Higher settings will result in more delay repeats.
HI CUT	20.0Hz–20.0kHz FLAT	This sets the frequency at which the high cut filter begins to take effect. When FLAT is selected, the high cut filter will have no effect.
E.LEVEL	0–120	Adjusts the volume of the delay sound.
D.LEVEL	0–100	Adjusts the volume of the direct sound.
BPM	40–250	Adjusts the BPM value for each patch. * BPM (beats per minute) indicates the number of quarter note beats that occur each minute * When you have an external MIDI device connected, the MASTER BPM synchronizes to the external MIDI devices tempo, making it impossible to set the MASTER BPM. To enable setting of the MASTER BPM, set “SYNCH CLOCK” (p. 47) to “INTERNAL.”

MASTER DELAY



This produces a variety of delay sounds ranging from simple effects to richly idiosyncratic sounds.

Parameter	Value	Explanation
ON/OFF	OFF, ON	Turns this effect on/off.
TYPE	This selects which type of delay. * If you switch patches with the Type set to DUAL and then begin to play immediately after the patches change, you may be unable to attain the intended effect in the first portion of what you perform. * The stereo effect is cancelled if a mono effect or AIRD PREAMP is connected after a stereo delay effect.	
	MONO	This is a simple mono delay.
	PAN	This delay is specifically for stereo output. This allows you to obtain the tap delay effect that divides the delay time, then deliver them to L and R channels.
	STEREO 1	The direct sound is output from the left channel, and the effect sound is output from the right channel.
	STEREO2	This is a stereo-in/out delay.
	ANALOG	This gives a mild analog delay sound. The delay time can be set within the range of 12 to 1,200 ms.
	ANALG ST	This gives a mild analog delay sound. The delay time can be set within the range of 12 to 1,200 ms. The direct sound is output from the left channel, and the effect sound is output from the right channel.
	TAPE	Provides the characteristic wavering sound of the tape echo.
	REVERSE	This produces an effect where the sound is played back in reverse.
	SHIMMER	Delay with pitch-shifted sound mixed in.
	DUAL	A delay comprising two different delays connected either in series or in parallel.
	WARP	Produces a dream-like sound.
	TWIST	Produces an aggressive sense of rotation. Using this in conjunction with distortion will produce an even wilder sense of rotation.
	WARM	A digital delay that's not excessively clear-sounding, with a warm sound.
	GLITCH	Produces a machine-gun-like delay sound.
	SPACE EC	This models the sound of the Roland RE-201.
	ECHO PX	This models the sound of the Maestro Echoplex.
	BIN ECHO	This models the sound of the Binson Echorec2.
	SDE-3000	This models the sound of the Roland SDE-3000.
	DD-20STD	This models the STANDARD mode of the BOSS DD-20.
DD-20ALG	This models the ANALOG mode of the BOSS DD-20.	

* Company names and product names appearing in this document are registered trademarks or trademarks of their respective owners.

* In this manual, company names and product names of the respective owners are used because it is the most practical way of describing the sounds that are emulated using DSP technology.

COMMON

* The COMMON parameters are not shown if TYPE is set to TWIST.

Parameter	Value	Explanation
TIME	1ms–2000ms, BPM	Adjusts the delay time. * When set to BPM, the value of each parameter will be set according to the value of the "MASTER BPM" specified for each patch. This makes it easier to achieve effect sound settings that match the tempo of the song. * If, due to the tempo, the time is longer than the range of allowable settings, it is then synchronized to a period either 1/2 or 1/4 of that time.
FEEDBACK	0–100	This sets the amount of delay sound returned to the input. A higher value will increase the number of the delay repeats.
HI CUT	20.0Hz–20.0kHz FLAT	This sets the frequency at which the high cut filter begins to take effect. When FLAT is selected, the high cut filter will have no effect.
E.LEVEL	0–120	Adjusts the volume of the delay sound.
MOD RATE	0–100	Adjusts the modulation rate of the delay sound.
MOD DEPT (MOD DEPTH)	0–100	Adjusts the modulation depth of the delay sound.
DUCK SENS (DUCK SENS)	0–100	Adjusts the sensitivity at which the volume is automatically adjusted according to the input. Higher values allow the adjustment to occur in response to lower volumes.
DUCK PRE (DUCK PRE DEPTH)	0–100	The volume being "input" to the delay is automatically reduced when the input sound is loud. The amount of reduction increases as this setting approaches 100.
DUCK PST (DUCK POST DEPTH)	0–100	The volume being "output" to the delay is automatically reduced when the input sound is loud. The amount of reduction increases as this setting approaches 100.
D.LEVEL	0–100	Adjusts the volume of the direct sound.
BPM	40–250	Adjusts the BPM value for each patch. * BPM (beats per minute) indicates the number of quarter note beats that occur each minute * When you have an external MIDI device connected, the MASTER BPM synchronizes to the external MIDI devices tempo, making it impossible to set the MASTER BPM. To enable setting of the MASTER BPM, set "SYNC CLOCK" (p. 47) to "INTERNAL."

PAN

Parameter	Value	Explanation
TAP TIME	0–100%	Adjusts the delay time of the right channel delay. This setting adjusts the R channel delay time relative to the L channel delay time (considered as 100%).

REVERSE

Parameter	Value	Explanation
AUTO TRIG	OFF, ON	When this is on, the start position for reverse playback is adjusted automatically.



TAPE

Parameter	Value	Explanation
HEAD	1, 1+2, 1+3, 2+3, 1+2+3	Selects the combination playback heads. Playback heads 2/3 provide delay times that are two times or three times as long as playback head 1.

SHIMMER

Parameter	Value	Explanation
PITCH	-24→24	Lets you freely specify the amount of pitch shift for the delay.
PITCH BL	0-100	Adjusts the balance between the pitch-shifted sound that is input to the delay and the direct sound.
PITCH FB	0-100	Adjusts the amount of feedback for the delay that is applied to the direct sound.

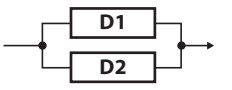
DUAL

Parameter	Value	Explanation
MODE	SERIES	This is a delay comprising two different delays connected in series. 
	PARALLEL	This is a delay comprising two delays connected in parallel. 
	L/R	This delay lets you specify the L and R channels independently. 
1:TYPE (D1 TYPE)	MONO	This is a simple mono delay.
	PAN	This delay is specifically for stereo output. This allows you to obtain the tap delay effect that divides the delay time, then deliver them to L and R channels.
2:TYPE (D2 TYPE)	ANALOG	This gives a mild analog delay sound.
	TAPE	This setting provides the characteristic wavering sound of the tape echo.
1:TIME (D1 TIME)	1ms-2000ms, BPM $\frac{60}{\text{BPM}}$ - $\frac{60}{\text{BPM}}$	Adjusts the delay time. * When set to BPM, the value of each parameter will be set according to the value of the "MASTER BPM" specified for each patch. This makes it easier to achieve effect sound settings that match the tempo of the song.
2:TIME (D2 TIME)		* If, due to the tempo, the time is longer than the range of allowable settings, it is then synchronized to a period either 1/2 or 1/4 of that time.
1:FEEDBK (D1 FEEDBACK)	0-100	Adjusts the amount of feedback of the DELAY 1 (or DELAY 2). A higher value will increase the number of the delay repeats.
2:FEEDBK (D2 FEEDBACK)		
1:HI CUT (D1 HIGH CUT)	20.0Hz-20.0kHz, FLAT	This sets the frequency at which the high cut filter begins to take effect. When FLAT is selected, the high cut filter will have no effect.
2:HI CUT (D2 HIGH CUT)		
1:LEVEL (D1 EFFECT LEVEL)	0-120	Adjusts the volume of the DELAY 1 (or DELAY 2).
2:LEVEL (D2 EFFECT LEVEL)		

WARP

Parameter	Value	Explanation
TRIGGER	OFF, ON	If this is ON, the WARP effect is applied.
LEVEL	0-100	Adjusts the volume of the effect sound.

TWIST

Parameter	Value	Explanation
MODE	FALL (RISE → FALL)	Rotation stops when you switch TRIGGER from ON to OFF.
	FADE (RISE → FADE)	When you switch TRIGGER from ON to OFF, fade-out occurs while continuing the rotation.
TRIGGER	OFF, ON	The TWIST effect is applied when you turn this ON.
RISE TIME	0-100	This parameter adjusts the amount of time it is to take for the effect to transition to the maximum.
FALL TIME *1	0-100	Adjusts the time for the rotation to stop when MODE is set to RISE → FALL.
FADE TIME *2	0-100	Adjusts the time to fade-out when MODE is set to RISE → FADE.
LEVEL	0-100	Adjusts the volume of the effect sound.

*1 Setting available when MODE is set to RISE → FALL.

*2 Setting available when MODE is set to RISE → FADE.

GLITCH

Parameter	Value	Explanation
TIME	40-1600 ms, BPM	Adjusts the delay time. The GLITCH effect uses short delay sounds, and you can set the times at which these four delay sounds are heard. * When set to BPM, the value of delay time will be set according to the value of the "MASTER BPM" specified for each patch. With the GLITCH effect, the delay time is set at 1/4th of the length, which is the time set based on the tempo.
TRIGGER	OFF, ON	The GLITCH effect is applied when you turn this ON.
DUTY	0-100	Adjusts the amount of GLITCH effect applied.

SPACE EC (SPACE ECHO)

Parameter	Value	Explanation
HEAD	1, 1+2, 1+3, 2+3, 1+2+3	Selects the combination playback heads. Playback heads 2/3 provide delay times that are two times or three times as long as playback head 1.
WOW&FLUT (WOW & FLUTTER)	0-100	Adjusts the wow & flutter.

ECHO PX (TAPE ECHO PX)

Parameter	Value	Explanation
WOW&FLUT (WOW & FLUTTER)	0–100	Adjusts the wow & flutter.

BIN ECHO (BIN DRUM ECHO)

Parameter	Value	Explanation
HEAD	1, 2, 3, 4, 1+2, 2+3, 3+4, 1+3, 2+4, 1+2+3, 2+3+4, 1+2+3+4	Selects the combination playback heads.
SELECTOR	ECHO, REPEAT, SWELL	Selects the operating mode of the delay. Depending on mode that's selected, the FEEDBACK will not work in some cases.
WOW&FLUT (WOW & FLUTTER)	0–100	Adjusts the wow & flutter.

SDE-3000

Parameter	Value	Explanation
FILTER	OFF, ON	Turns the filter on/off that's used to cut the high frequencies.
TIMEx2	OFF, ON	Sets whether to double the delay time by cutting the sampling frequency in half. When this is set to double (ON), you can set the delay time to a value within 1–4000 ms, or to the BPM.
DL PHASE (DELAY PHASE)	NORMAL, INVERT	Specifies the phase of the delay sound. Selecting INVERT inverts the phase.
FB PHASE (FEEDBACK PHASE)	NORMAL, INVERT	Specifies the phase of the delay sound feedback. Selecting INVERT inverts the phase.

DD-20STD (DD-20 STANDARD)

Parameter	Value	Explanation
TONE	0–100	Adjusts the tone. When the knob is in the center position, the response is flat. Turning the knob clockwise boosts the high-frequency range, and turning it counterclockwise cuts the high-frequency range.

DD-20ANG (DD-20 ANALOG)

Parameter	Value	Explanation
TONE	0–100	Adjusts the tone. When the knob is in the center position, the response is flat. Turning the knob clockwise boosts the high-frequency range, and turning it counterclockwise cuts the high-frequency range.

CHORUS





In this effect, a slightly detuned sound is added to the original sound to add depth and breadth.

COMMON

Parameter	Value	Explanation
ON/OFF	OFF, ON	Turns this effect on/off.
TYPE	Selection for the chorus mode.	
	MONO	This chorus effect outputs the same sound from both L channel and R channel.
	STEREO 1	This stereo chorus uses spatial synthesis, with the direct sound output in the L channel and the effect sound output in the R channel.
	STEREO2	This is a stereo chorus effect that adds different chorus sounds to L channel and R channel.
	DUAL	This lets you apply chorus independently to the L and R channels.
RATE	0–100, BPM	Adjusts the rate of the chorus effect. * When set to BPM, the value of each parameter will be set according to the value of the "MASTER BPM" specified for each patch. This makes it easier to achieve effect sound settings that match the tempo of the song. * If, due to the tempo, the time is longer than the range of allowable settings, it is then synchronized to a period either 1/2 or 1/4 of that time.
DEPTH	0–100	Adjusts the depth of the chorus effect. * To use it for doubling effect, set the value to 0.
PRE-DELY (PRE-DELAY)	0.0ms–40.0ms	Adjusts the time needed for the effect sound to be output after the direct sound has been output. By setting a longer pre delay time, you can obtain an effect that sounds like more than one sound is being played at the same time (doubling effect).
E.LEVEL	0–100	Adjusts the volume of the effect sound.
WAVEFORM	TRI	Produces a typical chorus effect.
	SINE	Produces a deeper sense of modulation.
LO CUT	FLAT, 20.0Hz–20.0kHz	This sets the frequency at which the low cut filter begins to take effect. When FLAT is selected, the low cut filter will have no effect.
HI CUT	20.0Hz–20.0kHz, FLAT	This sets the frequency at which the high cut filter begins to take effect. When FLAT is selected, the high cut filter will have no effect.
D.LEVEL	0–100	Adjusts the volume of the direct sound. Setting this to 0 cuts the direct sound.
BPM	40–250	Adjusts the BPM value for each patch. * BPM (beats per minute) indicates the number of quarter note beats that occur each minute * When you have an external MIDI device connected, the MASTER BPM synchronizes to the external MIDI devices tempo, making it impossible to set the MASTER BPM. To enable setting of the MASTER BPM, set "SYNC CLOCK" (p. 47) to "INTERNAL."

DUAL

Parameter	Value	Explanation
1:RATE 2:RATE	0–100, BPM 	Adjusts the rate of the chorus effect.
1:DEPTH 2:DEPTH	0–100	Adjusts the depth of the chorus effect. * To use it for doubling effect, set the value to 0.
1:PRE-DL 2:PRE-DL	0.0ms–40.0ms	Adjusts the time needed for the effect sound to be output after the direct sound has been output. By setting a longer pre delay time, you can obtain an effect that sounds like more than one sound is being played at the same time (doubling effect).
1:LEVEL 2:LEVEL	0–100	Adjusts the volume of the effect sound.
1:WAVE 2:WAVE	TRI  SINE 	Produces a typical chorus effect. Produces a deeper sense of modulation.
1:LO CUT 2:LO CUT	FLAT, 20.0Hz–20.0kHz	This sets the frequency at which the low cut filter begins to take effect. When FLAT is selected, the low cut filter will have no effect.
1:HI CUT 2:HI CUT	20.0Hz–20.0kHz, FLAT	This sets the frequency at which the high cut filter begins to take effect. When FLAT is selected, the high cut filter will have no effect.
D.LEVEL	0–100	Adjusts the volume of the direct sound. Setting this to 0 cuts the direct sound.
BPM	40–250	Adjusts the BPM value for each patch. * BPM (beats per minute) indicates the number of quarter note beats that occur each minute * When you have an external MIDI device connected, the MASTER BPM synchronizes to the external MIDI devices tempo, making it impossible to set the MASTER BPM. To enable setting of the MASTER BPM, set "SYNC CLOCK" (p. 47) to "INTERNAL."
OUTPUT	MONO STEREO	This setting is appropriate for mono output. Produces a rich spaciousness when stereo output is used.

FX1–FX3

With FX1, FX2, and FX3, you can select the effect to be used from the following. You can select the same effect for FX1, FX2, and FX3.

Parameter	Value	Explanation
ON/OFF	OFF, ON	Turns this effect on/off.
TYPE	Refer to FX1/FX2/FX3 TYPE	

FX1/FX2/FX3 TYPE

This is a list of the effects that can be selected for FX1/FX2/FX3.

Effect Name	Explanation
AC.G SIM (AC GUITAR SIM)	This effect simulates the tonal character of an acoustic guitar.
AC RESO (AC RESONANCE)	This processor allows you to change the sound produced by the pickup on an acoustic electric guitar, creating a richer sound similar to that obtained with a microphone placed close to the guitar.
AUTO WAH	This changes the filtering over a periodic cycle, providing an automatic wah effect.
CHORUS	In this effect, a slightly detuned sound is added to the original sound to add depth and breadth.
CHO BASS (CHORUS BASS)	
C-VIBE (CLASSIC-VIBE)	Although this resembles a phaser effect, it also provides a unique undulation that you can't get with a regular phaser.
COMP	This is an effect that produces a long sustain by evening out the volume level of the input signal. You can also use it as a limiter to suppress only the sound peaks and prevent distortion.
DEFRETR (DEFRETTER)	This simulates a fretless guitar.
DEFRET B (DEFRETTER BASS)	This simulates a fretless bass.
DIST (DISTORTION)	This effect distorts the sound to obtain long sustain.
FEEDBAKR (FEEDBACKER)	Generates feedback performance.
FLANGER	The flanging effect gives a twisting, jet-airplane-like character to the sound.
FLANGR B (FLANGER BASS)	
HARMONST (HARMONIST)	Harmonist is an effect where the amount of shifting is adjusted according to an analysis of the guitar input, allowing you to create harmony based on diatonic scales.
HUMANIZR (HUMANIZER)	This can create human vowel-like sounds.
MST.FX (MASTERING FX)	This effect can be used for full-fledged mastering, by raising the sound pressure levels and improving the clarity of the sound.
OCTAVE	This adds a note one octave lower and a note two octaves lower, creating a richer sound.
OCT BASS (OCTAVE BASS)	
OVERTONE	This effect uses MDP technology to add new harmonics to the sound, producing resonance and richness that was not present in the original sound.
PAN	With the volume level of the left and right sides alternately changing, when playing sound in stereo, you can get an effect that makes the guitar sound appear to fly back and forth between the speakers.
PHASER	By adding varied-phase portions to the direct sound, the phaser effect gives a whooshing, swirling character to the sound.
PITCH SFT (PITCH SHIFTER)	This effect changes the pitch of the original sound (up or down) within a range of two octaves.
RING MOD	This creates a bell-like sound by ring-modulating the guitar sound with the signal from the internal oscillator. The sound can be unmusical and lack distinctive pitches.
ROTARY	This produces an effect like the sound of a rotary speaker.
SITAR SIM	This simulates the sound of the sitar.

Effect Name	Explanation
SLICER	This consecutively interrupts the sound to create the impression that a rhythm backing phrase is being played.
SLW GEAR (SLOW GEAR)	This produces a volume-swell effect ("violin-like" sound).
SG BASS (SLOW GEAR BASS)	
SND HOLD (SOUND HOLD)	You can have sound played on the guitar be held continuously. This effect allows you to perform the melody in the upper registers while holding a note in the lower registers.
S-BEND	Applies intense bending.
TOUCH WH (TOUCH WAH)	You can produce a wah effect with the filter changing in response to the guitar level.
TW BASS (TOUCH WAH BASS)	You can produce a wah effect with the filter changing in response to the bass level.
TREMOLO	Tremolo is an effect that creates a cyclic change in volume.
VIBRATO	This effect creates vibrato by slightly modulating the pitch.

AC.G SIM (AC. GUITAR SIMULATOR) STEREO

This effect simulates the tonal character of an acoustic guitar.

Parameter	Value	Explanation
BODY	0-100	Adjusts the body resonance.
LO	-50+50	Specifies the sense of volume for the low-frequency range.
HI	-50+50	Specifies the sense of volume for the high-frequency range.
LEVEL	0-100	Specifies the volume of the effect.

AC RESO (AC RESONANCE) STEREO

This processor allows you to change the sound produced by the pickup on an acoustic electric guitar, creating a richer sound similar to that obtained with a microphone placed close to the guitar.

Parameter	Value	Explanation
TYPE	NATURAL	A natural and uncolored sound.
	WIDE	Mellow sound that emphasizes the body resonance
	BRIGHT	Brilliant sound with an extended high-frequency range
RESO	0-100	Use this knob to adjust the balance between the body resonance effect of the acoustic guitar and the direct sound of the pickup.
TONE	-50+50	Adjusts the tone.
LEVEL	0-100	Specifies the volume of the effect.

AUTO WAH STEREO

This changes the filtering over a periodic cycle, providing an automatic wah effect.

Parameter	Value	Explanation
FILTER	Selects the wah mode.	
	LPF	Low pass filter. Passes only the low-frequency region.
	HPF	High pass filter. Passes only the high-frequency region.
	BPF	Band pass filter. Passes only the specified frequency region.
RATE	0-100, BPM	Adjusts the frequency (speed) of the change. * When set to BPM, the value of each parameter will be set according to the value of the "MASTER BPM" specified for each patch. This makes it easier to achieve effect sound settings that match the tempo of the song. * If, due to the tempo, the time is longer than the range of allowable settings, it is then synchronized to a period either 1/2 or 1/4 of that time.
DEPTH	0-100	Adjusts the depth of the effect.
E.LEVEL	0-100	Adjusts the volume of the effect sound.
FREQ	0-100	Adjusts the center frequency of the Wah effect.
RESO	0-100	Adjusts the way in which the wah effect applies to the area around the center frequency.
WAVEFORM	TRI, SINE	Selects a wave type.
DIR MIX	0-100	Adjusts the volume of the direct sound.
BPM	40-250	Adjusts the BPM value for each patch. * BPM (beats per minute) indicates the number of quarter note beats that occur each minute * When you have an external MIDI device connected, the MASTER BPM synchronizes to the external MIDI devices tempo, making it impossible to set the MASTER BPM. To enable setting of the MASTER BPM, set "SYNC CLOCK" (p. 47) to "INTERNAL."

CHORUS



In this effect, a slightly detuned sound is added to the original sound to add depth and breadth.

COMMON

Parameter	Value	Explanation
ON/OFF	OFF, ON	Turns this effect on/off.
TYPE	Selection for the chorus mode.	
	MONO	This chorus effect outputs the same sound from both L channel and R channel.
	STEREO 1	This stereo chorus uses spatial synthesis, with the direct sound output in the L channel and the effect sound output in the R channel.
	STEREO2	This is a stereo chorus effect that adds different chorus sounds to L channel and R channel.
	DUAL	This lets you apply chorus independently to the L and R channels.
	PRIME	This is BOSS's proprietary chorus sound. It provides spaciousness and depth that were not previously obtainable.
	CE-1 CHO	The chorus sound of the CE-1.
CE-1 VIB	The vibrato sound of the CE-1.	
RATE	0–100, BPM	Adjusts the rate of the chorus effect. * When set to BPM, the value of each parameter will be set according to the value of the "MASTER BPM" specified for each patch. This makes it easier to achieve effect sound settings that match the tempo of the song. * If, due to the tempo, the time is longer than the range of allowable settings, it is then synchronized to a period either 1/2 or 1/4 of that time.
DEPTH	0–100	Adjusts the depth of the chorus effect. * To use it for doubling effect, set the value to 0.
E.LEVEL	0–100	Adjusts the volume of the effect sound.
PRE-DELY *1	0.0ms–40.0ms	Adjusts the time needed for the effect sound to be output after the direct sound has been output. By setting a longer pre delay time, you can obtain an effect that sounds like more than one sound is being played at the same time (doubling effect).
WAVEFORM *1	TRI	Produces a typical chorus effect.
	SINE	Produces a deeper sense of modulation.
LO CUT *1	FLAT, 20.0Hz–20.0kHz	This sets the frequency at which the low cut filter begins to take effect. When FLAT is selected, the low cut filter will have no effect.
HI CUT *1	20.0Hz–20.0kHz, FLAT	This sets the frequency at which the high cut filter begins to take effect. When FLAT is selected, the high cut filter will have no effect.
D.LEVEL	0–100	Adjusts the volume of the direct sound. Setting this to 0 cuts the direct sound.

Parameter	Value	Explanation
BPM	40–250	Adjusts the BPM value for each patch. * BPM (beats per minute) indicates the number of quarter note beats that occur each minute * When you have an external MIDI device connected, the MASTER BPM synchronizes to the external MIDI devices tempo, making it impossible to set the MASTER BPM. To enable setting of the MASTER BPM, set "SYNC CLOCK" (p. 47) to "INTERNAL."

*1 Not shown if TYPE is set to CE-1 CHO or CE-1 VIB.

DUAL

Parameter	Value	Explanation
1:RATE 2:RATE	0–100, BPM	Adjusts the rate of the chorus effect. * When set to BPM, the value of each parameter will be set according to the value of the "MASTER BPM" specified for each patch. This makes it easier to achieve effect sound settings that match the tempo of the song. * If, due to the tempo, the time is longer than the range of allowable settings, it is then synchronized to a period either 1/2 or 1/4 of that time.
1:DEPTH 2:DEPTH	0–100	Adjusts the depth of the chorus effect. * To use it for doubling effect, set the value to 0.
1:PRE-DL 2:PRE-DL	0.0ms–40.0ms	Adjusts the time needed for the effect sound to be output after the direct sound has been output. By setting a longer pre delay time, you can obtain an effect that sounds like more than one sound is being played at the same time (doubling effect).
1:LEVEL 2:LEVEL	0–100	Adjusts the volume of the effect sound.
1:WAVE 2:WAVE	TRI	Produces a typical chorus effect.
	SINE	Produces a deeper sense of modulation.
1:LO CUT 2:LO CUT	FLAT, 20.0Hz–20.0kHz	This sets the frequency at which the low cut filter begins to take effect. When FLAT is selected, the low cut filter will have no effect.
1:HI CUT 2:HI CUT	20.0Hz–20.0kHz, FLAT	This sets the frequency at which the high cut filter begins to take effect. When FLAT is selected, the high cut filter will have no effect.
D.LEVEL	0–100	Adjusts the volume of the direct sound. Setting this to 0 cuts the direct sound.
BPM	40–250	Adjusts the BPM value for each patch. * BPM (beats per minute) indicates the number of quarter note beats that occur each minute * When you have an external MIDI device connected, the MASTER BPM synchronizes to the external MIDI devices tempo, making it impossible to set the MASTER BPM. To enable setting of the MASTER BPM, set "SYNC CLOCK" (p. 47) to "INTERNAL."

PRIME

Parameter	Value	Explanation
SWEETNES (SWEETNESS)	0–100	Higher values produce a more enveloping sound.
BELL	0–100	Higher values produce a more brilliant sound.
OUTPUT	MONO	This setting is appropriate for mono output.
	STEREO	Produces a rich spaciousness when stereo output is used.





CE-1 CHORUS, CE-1 VIBRATO

Parameter	Value	Explanation
PREAMP (PREAMP SW)	OFF, ON	Specifies whether the CE-1's preamp is simulated (ON) or not simulated (OFF).
GAIN (PREAMP GAIN)	0–100	Adjusts the gain of the preamp. Higher settings will produce distortion.
LEVEL (PREAMP LEVEL)	0–100	Adjusts the volume of the preamp.

CHO BASS (CHORUS BASS)

MONO ▶ STEREO MONO

This is a chorus effect for bass.

Parameter	Value	Explanation
ON/OFF	OFF, ON	Turns this effect on/off.
TYPE	Selection for the chorus mode.	
	MONO 	This chorus effect outputs the same sound from both L channel and R channel.
	STEREO 1 	This stereo chorus uses spatial synthesis, with the direct sound output in the L channel and the effect sound output in the R channel.
	STEREO2 	This is a stereo chorus effect that adds different chorus sounds to L channel and R channel.
RATE	0–100, BPM 	Adjusts the rate of the chorus effect. * When set to BPM, the value of each parameter will be set according to the value of the "MASTER BPM" specified for each patch. This makes it easier to achieve effect sound settings that match the tempo of the song. * If, due to the tempo, the time is longer than the range of allowable settings, it is then synchronized to a period either 1/2 or 1/4 of that time.
DEPTH	0–100	Adjusts the depth of the chorus effect. * To use it for doubling effect, set the value to 0.
E.LEVEL	0–100	Adjusts the volume of the effect sound.
LO CUT *1	FLAT, 20.0Hz–20.0kHz	This sets the frequency at which the low cut filter begins to take effect. When FLAT is selected, the low cut filter will have no effect.
HI CUT *1	20.0Hz–20.0kHz, FLAT	This sets the frequency at which the high cut filter begins to take effect. When FLAT is selected, the high cut filter will have no effect.
BPM	40–250	Adjusts the BPM value for each patch. * BPM (beats per minute) indicates the number of quarter note beats that occur each minute * When you have an external MIDI device connected, the MASTER BPM synchronizes to the external MIDI devices tempo, making it impossible to set the MASTER BPM. To enable setting of the MASTER BPM, set "SYNC CLOCK" (p. 47) to "INTERNAL."

C-VIBE (CLASSIC VIBE)

STEREO







Although this resembles a phaser effect, it also provides a unique undulation that you can't get with a regular phaser.

Parameter	Value	Explanation
MODE	CHORUS	Direct sound and effect sound are mixed and output.
	VIBRATO	Only effect sound is output.
RATE	0–100, BPM 	Adjusts the rate of the effect. * When set to BPM, the value of each parameter will be set according to the value of the "MASTER BPM" specified for each patch. This makes it easier to achieve effect sound settings that match the tempo of the song. * If, due to the tempo, the time is longer than the range of allowable settings, it is then synchronized to a period either 1/2 or 1/4 of that time.
DEPTH	0–100	Adjusts the depth of the effect.
E.LEVEL	0–100	Adjusts the tone.
BPM	40–250	Adjusts the BPM value for each patch. * BPM (beats per minute) indicates the number of quarter note beats that occur each minute * When you have an external MIDI device connected, the MASTER BPM synchronizes to the external MIDI devices tempo, making it impossible to set the MASTER BPM. To enable setting of the MASTER BPM, set "SYNC CLOCK" (p. 47) to "INTERNAL."

COMP (COMPRESSOR)

STEREO

This is an effect that produces a long sustain by evening out the volume level of the input signal.

Parameter	Value	Explanation
ON/OFF	OFF, ON	Turns this effect on/off.
TYPE	BOSS COMP 	This models a BOSS CS-3.
	X-COMP 	This uses MDP to provide a consistently natural playing feel and sound that responds to the pitch range and dynamics of your phrases.
	D-COMP 	This models a MXR DynaComp.
	ORANGE 	This is modeled on the sound of the Dan Armstrong ORANGE SQUEEZER.
	STEREO COMP 	This selects a stereo compressor.
	X-BASS COMP 	This is a compressor for bass that uses MDP.
THRESHOLD *1	0–100	Adjust this as appropriate for the input signal. When the input signal level exceeds this threshold level, compression will be applied.
SUSTAIN *2	0–100	Adjusts the range (time) over which low-level signals are boosted. Larger values will result in longer sustain.
ATTACK	0–100	Adjusts the strength of the attack when picking.
LEVEL	0–100	Adjusts the volume.
tone	-50+50	Adjusts the tone.
RATIO	1:1–INF:1	Selects the compression ratio.
DIR MIX	0–100	Adjusts the volume of the direct sound.

*1 Setting available when TYPE is set to X-BASS COM.

*2 Not shown if TYPE is set to X-BASS COMP.

DEFRETR (DEFRETTER)

STEREO

This simulates a fretless guitar.

Parameter	Value	Explanation
SENS	0–100	This controls the input sensitivity of the defretter.
DEPTH	0–100	This controls the rate of the harmonics.
tone	-50+50	Adjusts the amount of blurring between the notes.
E.LEVEL	0–100	Adjusts the volume of the effect sound.
ATTACK	0–100	Adjusts the attack of the picking sound.
RESO	0–100	Adds a characteristically resonant quality to the sound.
DIR MIX	0–100	Adjusts the volume of the direct sound.

DEFRET B (DEFRETTER BASS)

STEREO

This simulates a fretless bass.

Parameter	Value	Explanation
SENS	0–100	This controls the input sensitivity of the defretter.
ATTACK	0–100	Adjusts the attack of the picking sound.
tone	-50+50	Adjusts the amount of blurring between the notes.
E.LEVEL	0–100	Adjusts the volume of the effect sound.
DIR MIX	0–100	Adjusts the volume of the direct sound.

DIST (DISTORTION)

MONO

This effect distorts the sound to create long sustain.

Parameter	Value	Explanation
ON/OFF	OFF, ON	Turns this effect on/off.
TYPE		Refer to "DISTORTION TYPE" (p. 17)
DRIVE	0–120	Adjusts the depth of distortion.
tone	-50+50	Adjusts the tone.
LEVEL	0–100	Adjusts the volume of the effect sound.
BOTTOM	-50+50	Adjusts the tone for the low frequency range. Turning this to the left (counterclockwise) produces a sound with the low end cut; turning it to the right boosts the low end in the sound.
DIR MIX	0–100	Adjusts the volume of the direct sound.
SOLO SW	OFF, ON	The tone to one suitable for solos.
SOLO LVL	0–100	Adjusts the volume level when the SOLO SW is ON.

DISTORTION TYPE

This is a list of distortion types that can be selected for DISTORTION.

Type	Explanation
MID	This is a booster with unique characteristics in the midrange. Making the connection before the AIRD PREAMP produces sound suitable for solos.
CLEAN	This not only functions as a booster, but also produces a clean tone that has punch even when used alone.
TREBLE	This is a booster that has bright characteristics.
CRUNCH	A lustrous crunch sound with an added element of amp distortion.

Type	Explanation
NATURAL	This is an overdrive sound that provides distortion with a natural feeling.
WARM OD	This is a warm overdrive.
FAT DS	A distortion sound with thick distortion.
LEAD DS	Produces a distortion sound with both the smoothness of an overdrive along with a deep distortion.
METAL DS	This is a distortion sound that is ideal for performances of heavy riffs.
OCT FUZZ	A fuzz sound with rich harmonic content.
A-DIST	This uses MDP technology to obtain ideal distortion in all ranges of the guitar, from low to high.
X-OD	This is an overdrive that uses MDP to obtain the distortion that's most appropriate in each pitch range.
X-DIST	This is a distortion that uses MDP to obtain the distortion that's most appropriate in each pitch range.
BLUES OD	This is a crunch sound of the BOSS BD-2. This produces distortion that faithfully reproduces the nuances of picking.
OD-1	This models the sound of the BOSS OD-1. This produces sweet, mild distortion.
SD-1	This models the sound of the BOSS SD-1.
T-SCREAM	This models an Ibanez TS-808.
TURBO OD	This is the high-gain overdrive sound of the BOSS OD-2.
DIST	This gives a basic, traditional distortion sound.
DS-1	This models the sound of the BOSS DS-1.
CENTA OD	This models a KLON CENTAUR.
RAT	This models a Proco RAT.
GUV DS	This models a Marshall GUV [®] NOR.
DIST+	This models the sound of the MXR DISTORTION+.
MTL ZONE	This models the sound of the BOSS MT-2. It produces a wide range of metal sounds, from old style to slash metal.
HM-2	This models the sound of the BOSS HM-2. It produces distinctive cranked-up distortion sound with compression.
MTL CORE	This is the sound of the BOSS ML-2 which is ideal for high speed metal riffs.
60S FUZZ	This models a FUZZFACE. It produces a fat fuzz sound.
MUFF FUZ	This models an Electro-Harmonix Big Muff π .
BASS OD	Overdrive tuned especially for use with basses.
BASS DS	Distortion tuned especially for use with basses.
BASS MT	Wild, radical distortion sound.
BASS FUZ	Fuzz tuned especially for use with basses.
HI BAND	With this effect, distortion is applied only to the high frequency sounds, and not to the sounds in the low frequency range.
X-BASS	This effect uses MDP to provide ideal distortion in all pitch ranges of the bass, from low to high.
BASS DRV	This models a TECH21 SANSAMP BASS DRIVER DI.
BASS DI	This models a MXR Bass DJ.+.

* Company names and product names appearing in this document are registered trademarks or trademarks of their respective owners.

* In this manual, company names and product names of the respective owners are used because it is the most practical way of describing the sounds that are emulated using DSP technology.

FEEDBAKR (FEEDBACKER)

STEREO

Generates feedback performance.

* Note that the notes you want to apply feedback to must be played singly and cleanly.

Parameter	Value	Explanation
MODE	NORMAL	Analyzes the pitch of the guitar sound being input, and then creates a feedback sound.
	OSC	An artificial feedback sound will be created internally. When OSC is selected, the effect is activated after a single note is played and the note stabilizes. A feedback effect is created when the effect switches on; the feedback disappears when the OSC effect switches off.
TRIGGER	OFF, ON	Feedback is applied if this is turned ON.
DEPTH *1	0–100	Adjusts the ease with which feedback will occur when the FEEDBACKER is on.
RISE TIME *2	0–100	This determines the time needed for the volume of the feedback sound to reach its maximum from the moment the effect is turned on.
OCT RISE *2	0–100	This determines the time needed for the volume of the one octave higher feedback sound to reach its maximum from the moment the effect is turned on.
FEEDBACK *2	0–100	Adjusts the volume of the feedback sound.
OCT FBK*2	0–100	Adjusts the volume of the one octave higher feedback sound.
VIB RATE *2	0–100	Adjusts the rate of the vibrato when the FEEDBACKER is on.
VIB DEPT *2	0–100	Adjusts the depth of the vibrato when the FEEDBACKER is on.

*1 MODE=NORMAL only

*2 MODE=OSC only

FLANGER/FLANGR B (FLANGER B)



The flanging effect gives a twisting, jet-airplane-like character to the sound.

Parameter	Value	Explanation
RATE	0–100, BPM	This sets the rate of the flanging effect. * When set to BPM, the value of each parameter will be set according to the value of the “MASTER BPM” specified for each patch. This makes it easier to achieve effect sound settings that match the tempo of the song. * If, due to the tempo, the time is longer than the range of allowable settings, it is then synchronized to a period either 1/2 or 1/4 of that time.
DEPTH	0–100	Determines the depth of the flanging effect.
RESO	0–100	Determines the amount of resonance (feedback). Increasing the value will emphasize the effect, creating a more unusual sound.
MANUAL	0–100	Adjusts the center frequency at which to apply the effect.
TURBO	OFF, ON	If this is “ON,” a more intense effect is produced.
WAVEFORM	TRI, SINE	Selects the type of wave.
STEP	OFF, 0–100, BPM	Adjusts the rate of the step function which varies the rotation in a step-wise manner. Higher settings make the change occur in smaller steps. Turn this “OFF” if you don’t want to use the step function.
SEPARATE	0, 15, 30, 45, 60, 75, 90, 105, 120, 135, 150, 165, 180	Adjusts the diffusion. The diffusion increases as the value increases.
E.LEVEL	0–100	Adjusts the volume of the flanger.
LO DAMP	-100–0	Adjusts the amount of feedback for the low-frequency region.
HI DAMP	-100–0	Adjusts the amount of feedback for the high-frequency region.
LO CUT	FLAT, 20.0Hz–20.0kHz	This sets the frequency at which the low cut filter begins to take effect. When FLAT is selected, the low cut filter will have no effect.
HI CUT	20.0Hz–20.0kHz, FLAT	This sets the frequency at which the high cut filter begins to take effect. When FLAT is selected, the high cut filter will have no effect.
DIR MIX	0–100	Adjusts the volume of the direct sound.
BPM	40–250	Adjusts the BPM value for each patch. * BPM (beats per minute) indicates the number of quarter note beats that occur each minute * When you have an external MIDI device connected, the MASTER BPM synchronizes to the external MIDI devices tempo, making it impossible to set the MASTER BPM. To enable setting of the MASTER BPM, set “SYNC CLOCK” (p. 47) to “INTERNAL.”

HARMONST (HARMONIST)



Harmonist is an effect where the amount of shifting is adjusted according to an analysis of the guitar input, allowing you to create harmony based on diatonic scales.

- * Because of the need to analyze the pitch, chords (two or more sounds played simultaneously) cannot be played. Be sure to mute all the other strings and play only one note at a time.
- * When you are to play the next string while a certain sound is still playing, mute the previous sound and then play the next one with a clear attack. If the unit cannot detect the attack, it may not sound correctly.
- * The sensitivity may vary according to the guitar’s TONE knob and pickup type.

Parameter	Value	Explanation
VOICE	1VOICE	Selects the number of voices for the pitch shift sound. One-voice pitch-shifted sound output in mono.
	2MONO	Two-voice pitch-shifted sound (HR1, HR2) output in mono.
	2STEREO	Two-voice pitch-shifted sound (HR1, HR2) output through left and right channels.
1:HARMO 2:HARMO	-2oct→+2oct, USER	This determines the pitch of the sound added to the input sound, when you are making a harmony. It allows you to set it by up to 2 octaves higher or lower than the input sound. When the scale is set to USER, this parameter sets the user scale number to be used.
KEY	C (Am)– B (G#m)	The key setting corresponds to the key of the song (#, b) as follows. Major C F B ^b E ^b A ^b D ^b Minor A ^m D ^m G ^m C ^m F ^m B ^b ^m Major C G D A E B F [#] Minor A ^m E ^m B ^m F [#] ^m C [#] ^m G [#] ^m D [#] ^m
1:LEVEL 2:LEVEL	0–100	Adjusts the volume of the harmony sound.
1:PRE-DL 2:PRE-DL	0–300ms, BPM	Adjusts the time from when the direct sound is heard until the harmonist sounds are heard. Normally you can leave this set at 0 ms. * When set to BPM, the value of each parameter will be set according to the value of the “MASTER BPM” specified for each patch. This makes it easier to achieve effect sound settings that match the tempo of the song. * If, due to the tempo, the time is longer than the range of allowable settings, it is then synchronized to a period either 1/2 or 1/4 of that time.
1:FEEDBK	0–100	Adjusts the feedback amount of the harmonist sound.
D.LEVEL	0–100	Adjusts the volume of the direct sound.
BPM	40–250	Adjusts the BPM value for each patch. * BPM (beats per minute) indicates the number of quarter note beats that occur each minute * When you have an external MIDI device connected, the MASTER BPM synchronizes to the external MIDI devices tempo, making it impossible to set the MASTER BPM. To enable setting of the MASTER BPM, set “SYNC CLOCK” (p. 47) to “INTERNAL.”

USER SCALE

* Effective with USER selected for HARM parameter.

Parameter	Value
C	▼C-▼C-C-▲C-▲C
D _b	▼D _b -▼D _b -D _b -▲D _b -▲D _b
D	▼D-▼D-D-▲D-▲D
E _b	▼E _b -▼E _b -E _b -▲E _b -▲E _b
E	▼E-▼E-E-▲E-▲E
F	▼F-▼F-F-▲F-▲F
F _‡	▼F _‡ -▼F _‡ -F _‡ -▲F _‡ -▲F _‡
G	▼G-▼G-G-▲G-▲G
A _b	▼A _b -▼A _b -A _b -▲A _b -▲A _b
A	▼A-▼A-A-▲A-▲A
B _b	▼B _b -▼B _b -B _b -▲B _b -▲B _b
B	▼B-▼B-B-▲B-▲B

Specify the note name of the output sound. The minus (-) and plus (+) symbols indicate sounds above or below the specified original note.

Triangles next to the note names indicate octaves.

One downward-pointing triangle indicates a note one octave below the note displayed; two triangles indicates a two-octave drop.

One upward-pointing triangle indicates a note one octave above the note displayed; two triangles indicates a two-octave rise.

HUMANIZR (HUMANIZER)

STEREO

This can create human vowel-like sounds.

Parameter	Value	Explanation
MODE	This sets the mode that switches the vowels.	
	PICKING	It changes from VOWEL 1 to VOWEL 2 along with the picking. The time spent for the change is adjusted with the rate.
	AUTO	By adjusting the rate and depth, two vowels (VOWEL 1 and VOWEL 2) can be switched automatically.
VOWEL 1	a, e, i, o, u	Selects the first vowel.
VOWEL 2	a, e, i, o, u	Selects the second vowel.
SENS *1	0-100	Adjusts the sensitivity of the humanizer. When it is set to a lower value, no effect of the humanizer is obtained with weaker picking, while stronger picking produces the effect. When it is set to a higher value, the effect of the humanizer can be obtained whether the picking is weak or strong.
RATE	0-100, BPM 	Adjusts the cycle for changing the two vowels. * When set to BPM, the value of each parameter will be set according to the value of the "MASTER BPM" specified for each patch. This makes it easier to achieve effect sound settings that match the tempo of the song. * If, due to the tempo, the time is longer than the range of allowable settings, it is then synchronized to a period either 1/2 or 1/4 of that time.
DEPTH	0-100	Adjusts the depth of the effect.
MANUAL *2	0-100	This determines the point where the two vowels are switched. When it is set to 50, VOWEL 1 and VOWEL 2 are switched in the same length of time. When it is set to lower than 50, the time for VOWEL 1 is shorter. When it is set to higher than 50, the time for VOWEL 1 is longer.
LEVEL	0-100	Adjusts the tone.
BPM	40-250	Adjusts the BPM value for each patch. * BPM (beats per minute) indicates the number of quarter note beats that occur each minute * When you have an external MIDI device connected, the MASTER BPM synchronizes to the external MIDI devices tempo, making it impossible to set the MASTER BPM. To enable setting of the MASTER BPM, set "SYNC CLOCK" (p. 47) to "INTERNAL."

*1 Setting available when MODE is set to PICKING.

*2 Setting available when MODE is set to AUTO.

MST.FX (MASTERING FX)

STEREO

A general mastering effect that combines multiple effects including a multiband compressor, limiter, enhancer, equalizer and more.

When recording or playing back what you performed in the line-level environment, the overall volume needs to be brought down so that the loudest parts that you play can fit within the playback range. However, doing this may bring down the overall volume, making the performance sound lackluster.

Further, the level meters may peak out in the low frequency ranges that are harder for humans to hear, but the actual sound produced may seem quiet. For this reason, such an effect may get in the way of the impactful playback of your performance.

By using the mastering effect, you can avoid inconsistencies in volume when you play, and smooth out the low-frequency balance. This gives the effect of raising the sound pressure levels and improving the clarity of the sound.

We recommend that you use MST.FX after the SPSIMULATOR in the signal chain.

Parameter	Value	Explanation
TYPE	NAT.COMP (NATURAL COMP)	Makes excessive input levels sound more natural based on the nuances of your playing, reducing inconsistencies in volume during your performance.
	MIXERCMP (MIXER COMP)	Keeps down unwanted low and high frequencies, making the sound stand out clearly.
	LIVECOMP	Emphasizes the low and high frequencies to create a brilliant sound, like the sound of recording live.
	NAT.LIM (NATURAL LIMITER)	A limiter is applied only to signals that are louder than the specified level, retaining a natural performance feel.
	HARD LIM (HARD LIMITER)	Inconsistencies in volume are smoothed out by applying stronger limits to the signal levels.
	SOLO	Makes the main sonic range you're playing in stand out more clearly, such as for melodies, solo parts and so on.
	METAL	Keeps down unwanted low frequencies, making the sound stand out clearly over a wide frequency range to deliver a sound with impact.
	ACOUSTIC	Emphasizes the mid- to high-frequency ranges for a more delicate acoustic sound.
	ROCK	Produces a straight-out rock sound with impact.
	LOWBOOST	Emphasizes the low end.
BRIGHTEN	Emphasizes the high end.	
DYNAMICS	-20~+20	Adjusts the variation in volume between loud and soft passages in the performance. Raising this setting will decrease the variation in volume. Although this is a convenient way to improve the overall loudness for your song, it will decrease the natural dynamics of the music. Lowering this setting will increase the variation in volume; while this will make it difficult to obtain overall loudness for your song, the music will be closer to the natural dynamic variation of the original performance. If this setting is at 0, the mastering effect will produce its standard effect.
TONE	-6~+6	If you raise this setting, the low-frequency and high-frequency ranges will be boosted, producing a more aggressive tone. If you lower this setting, the low-frequency and high-frequency ranges will not be boosted, and the tone will be mild. If this setting is at 0, the mastering effect will produce its standard effect.
NATURAL	-50~+50	If you raise this setting, the mastering effect will be applied more gently, producing a more natural impression. Since sudden peaks in volume will still be reproduced without modification, this will make it more difficult to boost the overall loudness. If you lower this setting, the mastering effect will be applied more rapidly to sudden volume peaks, but the sense of naturalness will be impaired. If this setting is at 0, the mastering effect will produce its standard effect.

OCTAVE

MONO

This adds a note one octave lower and a note two octaves lower, creating a richer sound.

Parameter	Value	Explanation
TYPE	MONO	Adds a note one octave lower and a note two octaves lower than the input. This supports mono input.
	POLY	Adds a note one octave lower than the input. This supports polyphonic input.
-2OCT *1	0-100	Adjusts the volume of the sound two octave below.
-1OCT *1	0-100	Adjusts the volume of the sound one octaves below.
D.LEVEL	0-100	Adjusts the volume of the direct sound.
RANGE *2	0-100	This selects the register to which the effect is applied.
OC.LEVEL *2	0-100	Adjusts the volume of the sound one octave below.

*1 Setting available when TYPE is set to MONO.

*2 Setting available when TYPE is set to POLY.

OCT BASS (OCTAVE BASS)

MONO

This is an OCTAVE effect for bass.

Parameter	Value	Explanation
-2OCT	0-100	Adjusts the volume of the sound two octave below.
-1OCT	0-100	Adjusts the volume of the sound one octaves below.
D.LEVEL	0-100	Adjusts the volume of the direct sound.

OVERTONE

MONO STEREO MONO

This effect uses MDP technology to add new harmonics to the sound, producing resonance and richness that was not present in the original sound.

Parameter	Value	Explanation
LOWER	0-100	Adjusts the volume of the harmonic one octave below.
UPPER	0-100	Adjusts the volume of the harmonic one octave above.
UNISON	0-100	Adjusts the volume of added sound whose pitch is slightly shifted relative to the direct sound.
D.LEVEL	0-100	Adjusts the volume of the direct sound.
DETUNE	0-100	Adjusts the amount of the detune effect that adds depth to the sound.
LO	-50~+50	Adjusts the tonal character of the low-frequency range.
HI	-50~+50	Adjusts the tonal character of the high-frequency range.
OUTPUT	MONO, STEREO	Selects the type of output.

PAN

STEREO

With the volume level of the left and right sides alternately changing, when playing sound in stereo, you can get an effect that makes the guitar sound appear to fly back and forth between the speakers.

Parameter	Value	Explanation
RATE	0–100, BPM 	Adjusts the frequency (speed) of the change. * When set to BPM, the value of each parameter will be set according to the value of the “MASTER BPM” specified for each patch. This makes it easier to achieve effect sound settings that match the tempo of the song. * If, due to the tempo, the time is longer than the range of allowable settings, it is then synchronized to a period either 1/2 or 1/4 of that time.
DEPTH	0–100	Adjusts the depth of the effect.
WAVEFORM	0–100	Adjusts changes in volume level. A higher value will steepen wave's shape.
E.LEVEL	0–100	Adjusts the volume.
DIR MIX	0–100	Adjusts the volume of the direct sound.
BPM	40–250	Adjusts the BPM value for each patch. * BPM (beats per minute) indicates the number of quarter note beats that occur each minute * When you have an external MIDI device connected, the MASTER BPM synchronizes to the external MIDI devices tempo, making it impossible to set the MASTER BPM. To enable setting of the MASTER BPM, set “SYNC CLOCK” (p. 47) to “INTERNAL.”

PHASER

MONO
STEREO

By adding varied-phase portions to the direct sound, the phaser effect gives a whooshing, swirling character to the sound.

Parameter	Value	Explanation
TYPE		Selects the PHASER type.
	PRIME	An original BOSS phaser. This provides modulation that is not obtainable from previous units.
	SCRIPT	Models the MXR Phase 90 which was manufactured during the '70s.
STAGE *1	2, 4, 8, 16, 24STAGE	Selects the number of stages that the phaser effect will use.
RATE	0–100, BPM 	This sets the rate of the phaser effect. * When set to BPM, the value of each parameter will be set according to the value of the “MASTER BPM” specified for each patch. This makes it easier to achieve effect sound settings that match the tempo of the song. * If, due to the tempo, the time is longer than the range of allowable settings, it is then synchronized to a period either 1/2 or 1/4 of that time.
DEPTH	0–100	Determines the depth of the phaser effect.
RESO *1	0–100	Determines the amount of resonance (feedback). Increasing the value will emphasize the effect, creating a more unusual sound.
MANUAL *1	0–100	Adjusts the center frequency of the phaser effect.

Parameter	Value	Explanation
WAVEFORM *1	TRI, SINE	Selects the type of wave.
STEP *1	OFF, 0–100, BPM 	This sets the cycle of the step function that changes the rate and depth. When it is set to a higher value, the change will be finer. Set this to “Off” when not using the Step function. * When set to BPM, the value of each parameter will be set according to the value of the “MASTER BPM” specified for each patch. This makes it easier to achieve effect sound settings that match the tempo of the song. * If, due to the tempo, the time is longer than the range of allowable settings, it is then synchronized to a period either 1/2 or 1/4 of that time.
BI-PHASE *1	OFF, ON	Specifies whether the two phase shift circuits are connected in series (ON) or not (OFF).
SEPARATE *1	0, 15, 30, 45, 60, 75, 90, 105, 120, 135, 150, 165, 180	Adjusts the diffusion. The diffusion increases as the value increases.
LO DAMP *1	-100–0	Adjusts the amount of feedback for the low-frequency region.
HI DAMP *1	-100–0	Adjusts the amount of feedback for the high-frequency region.
LO CUT *1	FLAT, 20.0Hz– 20.0kHz	This sets the frequency at which the low cut filter begins to take effect. When FLAT is selected, the low cut filter will have no effect.
HI CUT *1	20.0Hz– 20.0kHz, FLAT	This sets the frequency at which the high cut filter begins to take effect. When FLAT is selected, the high cut filter will have no effect.
E.LEVEL	0–100	Adjusts the volume.
DIR MIX	0–100	Adjusts the volume of the direct sound.
BPM	40–250	Adjusts the BPM value for each patch. * BPM (beats per minute) indicates the number of quarter note beats that occur each minute * When you have an external MIDI device connected, the MASTER BPM synchronizes to the external MIDI devices tempo, making it impossible to set the MASTER BPM. To enable setting of the MASTER BPM, set “SYNC CLOCK” (p. 47) to “INTERNAL.”

*1 Setting available when TYPE is set to PRIME.

* Company names and product names appearing in this document are registered trademarks or trademarks of their respective owners.

* In this manual, company names and product names of the respective owners are used because it is the most practical way of describing the sounds that are emulated using DSP technology.

PITCH SFT (PITCH SHIFTER)



This effect changes the pitch of the original sound (up or down) within a range of two octaves.

Parameter	Value	Explanation
VOICE	Selects the number of voices for the pitch shift sound.	
	1VOICE	One-voice pitch-shifted sound output in mono.
	2MONO	Two-voice pitch-shifted sound (PS1, PS2) output in mono.
	2STEREO	Two-voice pitch-shifted sound (PS1, PS2) output through left and right channels.
1:PITCH 2:PITCH	-24+24	Adjusts the amount of pitch shift (the amount of interval) in semitone steps.
D.LEVEL	0-100	Adjusts the volume of the direct sound.
1:MODE 2:MODE	Selection for the pitch shifter mode.	
	FAST, MEDIUM, SLOW	The response is slower in the order of FAST, MEDIUM and SLOW, but the modulation is lessened in the same order.
	MONO	MONO is used for inputting single notes. * You may be unable to produce the intended effect when playing chords (two or more notes played simultaneously).
1:FINE 2:FINE	-50+50	Make fine adjustments to the interval. The amount of the change in the Fine 100 is equivalent to that of the Pitch 1.
1:PRE-DL 2:PRE-DL	0ms-300ms, BPM	Adjusts the time from when the direct sound is heard until the pitch shifted sounds are heard. Normally you can leave this set at 0 ms. * When set to BPM, the value of each parameter will be set according to the value of the "MASTER BPM" specified for each patch. This makes it easier to achieve effect sound settings that match the tempo of the song. * If, due to the tempo, the time is longer than the range of allowable settings, it is then synchronized to a period either 1/2 or 1/4 of that time.
1:LEVEL 2:LEVEL	0-100	Adjusts the volume of the pitch shifter.
1:FEEDBK	0-100	Adjusts the feedback amount of the pitch shift sound.
BPM	40-250	Adjusts the BPM value for each patch. * BPM (beats per minute) indicates the number of quarter note beats that occur each minute * When you have an external MIDI device connected, the MASTER BPM synchronizes to the external MIDI devices tempo, making it impossible to set the MASTER BPM. To enable setting of the MASTER BPM, set "SYNC CLOCK" (p. 47) to "INTERNAL."

RING MOD





This creates a bell-like sound by ring-modulating the guitar sound with the signal from the internal oscillator. The sound can be unmusical and lack distinctive pitches.

Parameter	Value	Explanation
INTELLI	OFF, ON	If this is ON, the oscillator frequency changes according to the pitch of the input sound, producing a pitched sound. In this case, the expected effect does not occur if the pitch of the guitar sound is not detected correctly. We recommend that you use this with single-note playing.
FREQ	0-100	Adjusts the frequency of the internal oscillator.
MOD RATE	0-100, BPM	Adjusts the rate at which the internal oscillator is modulated. * When set to BPM, the value of each parameter will be set according to the value of the "MASTER BPM" specified for each patch. This makes it easier to achieve effect sound settings that match the tempo of the song. * If, due to the tempo, the time is longer than the range of allowable settings, it is then synchronized to a period either 1/2 or 1/4 of that time.
MOD DEPT	0-100	Adjusts the depth to which the internal oscillator is modulated.
E.LEVEL	0-100	Adjusts the volume of the effect sound.
DIR MIX	0-100	Adjusts the volume of the direct sound.
BPM	40-250	Adjusts the BPM value for each patch. * BPM (beats per minute) indicates the number of quarter note beats that occur each minute * When you have an external MIDI device connected, the MASTER BPM synchronizes to the external MIDI devices tempo, making it impossible to set the MASTER BPM. To enable setting of the MASTER BPM, set "SYNC CLOCK" (p. 47) to "INTERNAL."

ROTARY

 MONO
STEREO

This produces an effect like the sound of a rotary speaker.

Parameter	Value	Explanation
SPEED	SLOW, FAST	This parameter changes the simulated speaker's rotating speed (SLOW or FAST).
SLOW	0–100, BPM 	This parameter adjusts the SPEED SELECT of rotation when set to "SLOW."
FAST	0–100, BPM 	This parameter adjusts the SPEED SELECT of rotation when set to "FAST."
E.LEVEL	0–100	Adjusts the volume.
RISE TIME	0–100	This parameter adjusts the time it takes for the rotation SPEED SELECT to change when switched from "SLOW" to "FAST."
FALL TIME	0–100	This parameter adjusts the time it takes for the rotation SPEED SELECT to change when switched from "FAST" to "SLOW."
MIC DIST	0–100	Adjusts the distance between the horn/rotor and the mic.
ROT/HORN	100:0–0:100	Adjusts the volume balance between the horn and rotor.
DRIVE	0–100	Adjusts the amount of distortion in the preamp.
DIR MIX	0–100	Adjusts the volume of the direct sound.
BPM	40–250	Adjusts the BPM value for each patch. * BPM (beats per minute) indicates the number of quarter note beats that occur each minute * When you have an external MIDI device connected, the MASTER BPM synchronizes to the external MIDI devices tempo, making it impossible to set the MASTER BPM. To enable setting of the MASTER BPM, set "SYNC CLOCK" (p. 47) to "INTERNAL."

SITAR SIM.

STEREO

This simulates the sound of the sitar.

Parameter	Value	Explanation
SENS	0–100	Adjusts the sensitivity of the sitar. When it is set to a lower value, no effect of the sitar is obtained with weaker picking, while stronger picking produces the effect. When it is set to a higher value, the effect of the sitar can be obtained whether the picking is weak or strong.
DEPTH	0–100	This adjusts the amount of effect applied.
TONE	-50+50	This adjusts the tone. The high end is boosted as the value increases.
E.LEVEL	0–100	Adjust the volume of the sitar sound.
RESO	0–100	This adjusts the undulation of the resonance.
BUZZ	0–100	Adjusts the amount of characteristic buzz produced by the "buzz bridge" when the strings make contact with it.
DIR MIX	0–100	Adjusts the volume of the direct sound.

SLICER

STEREO

This consecutively interrupts the sound to create the impression that a rhythm backing phrase is being played.

Parameter	Value	Explanation
PATTERN	P1–P20	Select the slice pattern that will be used to cut the sound.
RATE	0–100, BPM 	Adjust the rate at which the sound will be cut. * When set to BPM, the value of each parameter will be set according to the value of the "MASTER BPM" specified for each patch. This makes it easier to achieve effect sound settings that match the tempo of the song. * If, due to the tempo, the time is longer than the range of allowable settings, it is then synchronized to a period either 1/2 or 1/4 of that time.
TRIGGER	OFF, ON	When you switch this from OFF to ON, the rhythm pattern returns to its beginning. • When the patch is written, the TRIGGER parameter is stored in the OFF state.
E.LEVEL	0–100	Adjusts the volume of the effect sound.
ATTACK	0–100	Adjusts the volume of the attacks for the slice pattern.
DUTY	1–99	Adjusts the duration of the sound for the slice pattern.
DIR MIX	0–100	Adjusts the volume of the direct sound.
BPM	40–250	Adjusts the BPM value for each patch. * BPM (beats per minute) indicates the number of quarter note beats that occur each minute * When you have an external MIDI device connected, the MASTER BPM synchronizes to the external MIDI devices tempo, making it impossible to set the MASTER BPM. To enable setting of the MASTER BPM, set "SYNC CLOCK" (p. 47) to "INTERNAL."

SLW GEAR (SLOW GEAR)/ SG BASS (SLOW GEAR BASS)

STEREO

This produces a volume-swell effect ("violin-like" sound).

Parameter	Value	Explanation
SENS	0–100	Adjusts the sensitivity of the slow gear. When it is set to a lower value, the effect of the slow gear can be obtained only with a stronger picking, while no effect is obtained with a weaker picking. When the value is set higher, the effect is obtained even with a weak picking.
RISE TIME	0–100	Adjusts the time needed for the volume to reach its maximum from the moment you begin picking.
LEVEL	0–100	Adjusts the volume of the effect sound.

SND HOLD (SOUND HOLD)

STEREO

You can have sound played on the guitar be held continuously. This effect allows you to perform the melody in the upper registers while holding a note in the lower registers.

* This function will not work properly when two or more notes are played simultaneously.

Parameter	Value	Explanation
TRIGGER	OFF, ON	Switches the hold sound on and off. Normally, this is controlled with the CTL pedals. • It is assumed that this parameter will be assigned to the footswitch. • Patches are written with the HOLD parameter set to Off.
RISE TIME	0–100	Adjusts how rapidly the Sound Hold sound is produced.
E.LEVEL	0–120	Adjusts the volume of the hold sound.

S-BEND

MONO

Applies intense bending.

Parameter	Value	Explanation
TRIGGER	OFF, ON	The effect is applied when you switch this from OFF to ON. When the patch is written, this parameter is stored in the OFF state.
PITCH	-3oct, -2oct, -1oct, +1oct, +2oct, +3oct, +4oct	Adjusts the amount of pitch shift in octave steps.
RISE TIME	0-100	This parameter adjusts the amount of time it is to take for the effect to transition to the maximum.
FALL TIME	0-100	This parameter adjusts the amount of time it is to take for the effect to transition to the original.

TOUCH WH (TOUCH WAH)/
TW BASS (TOUCH WAH BASS)

STEREO

You can produce a wah effect with the filter changing in response to the guitar/bass level.

Parameter	Value	Explanation
FILTER		Selects the wah mode.
	LPF	Low pass filter. Passes only the low-frequency region.
	HFP	High pass filter. Passes only the high-frequency region.
	BPF	Band pass filter. Passes only the specified frequency region.
POLARITY		Selects the direction in which the filter will change in response to the input.
	DOWN	The frequency of the filter will fall.
	UP	The frequency of the filter will rise.
SENS	0-100	Specifies the sensitivity with which the filter moves in the direction specified by the POLARITY setting. Higher values will result in a stronger response. With a setting of 0, the strength of picking will have no effect.
SENS	0-100	Adjusts the center frequency of the Wah effect.
FREQ	0-100	Adjusts the way in which the wah effect applies to the area around the center frequency. Higher values will produce a stronger tone which emphasizes the wah effect more. With a value of 50 a standard wah sound will be produced.
DECAY	0-100	Adjusts the rate at which the filter is moved.
E.LEVEL	0-100	Adjusts the volume of the effect sound.
DIR MIX	0-100	Adjusts the volume of the direct sound.

TREMOLO

STEREO

Tremolo is an effect that creates a cyclic change in volume.

Parameter	Value	Explanation
RATE	0-100, BPM 	Adjusts the frequency (speed) of the change. * When set to BPM, the value of each parameter will be set according to the value of the "MASTER BPM" specified for each patch. This makes it easier to achieve effect sound settings that match the tempo of the song. * If, due to the tempo, the time is longer than the range of allowable settings, it is then synchronized to a period either 1/2 or 1/4 of that time.
DEPTH	0-100	Adjusts the depth of the effect.
WAVEFORM	0-100	Adjusts changes in volume level. A higher value will steepen wave's shape.
E.LEVEL	0-100	Adjusts the volume.
TRIGGER	OFF, ON	Turns the tremolo on/off.
RISE TIME	0-100	Specifies the time from when trigger turns on until the specified tremolo effect is obtained.
DIR MIX	0-100	Adjusts the volume of the direct sound.
BPM	40-250	Adjusts the BPM value for each patch. * BPM (beats per minute) indicates the number of quarter note beats that occur each minute * When you have an external MIDI device connected, the MASTER BPM synchronizes to the external MIDI devices tempo, making it impossible to set the MASTER BPM. To enable setting of the MASTER BPM, set "SYNC CLOCK" (p. 47) to "INTERNAL."

VIBRATO

STEREO

This effect creates vibrato by slightly modulating the pitch.

Parameter	Value	Explanation
RATE	0-100, BPM 	Adjusts the rate of the vibrato. * When set to BPM, the value of each parameter will be set according to the value of the "MASTER BPM" specified for each patch. This makes it easier to achieve effect sound settings that match the tempo of the song. * If, due to the tempo, the time is longer than the range of allowable settings, it is then synchronized to a period either 1/2 or 1/4 of that time.
DEPTH	0-100	Adjusts the depth of the vibrato.
COLOR	0-100	Higher settings produce a more complex modulation.
E.LEVEL	0-100	Adjusts the volume.
TRIGGER	OFF, ON	This selects on/off of the vibrato.
RISE TIME	0-100	This sets the time passing from the moment the Trigger is turned on until the set vibrato is obtained.
DIR MIX	0-100	Adjusts the volume of the direct sound.
BPM	40-250	Adjusts the BPM value for each patch. * BPM (beats per minute) indicates the number of quarter note beats that occur each minute * When you have an external MIDI device connected, the MASTER BPM synchronizes to the external MIDI devices tempo, making it impossible to set the MASTER BPM. To enable setting of the MASTER BPM, set "SYNC CLOCK" (p. 47) to "INTERNAL."

REVERB MONO STEREO

This effect adds reverberation to the sound.

Parameter	Value	Explanation
ON/OFF	OFF, ON	Turns this effect on/off.
TYPE	This selects the reverb type. Various different simulations of space are offered.	
	HALL 1	Simulates the reverberation in a concert hall. Provides clear and spacious reverberations.
	HALL 2	Simulates the reverberation in a concert hall. Provides mild reverberations.
	PLATE	Simulates plate reverberation (a reverb unit that uses the vibration of a metallic plate). Provides a metallic sound with a distinct upper range.
	ROOM1	Simulates the reverberation in a small room. Provides warm reverberations.
	ROOM2	Simulates the reverberation of a room larger than ROOM1.
	AMBIENCE	Simulates an ambience mic (off-mic, placed at a distance from the sound source) used in recording and other applications. Rather than emphasizing the reverberation, this reverb is used to produce a sense of openness and depth.
	SPRING	This simulates the sound of a guitar amp's built-in spring reverb.
	SHIMMER	Simulates reverberation with a distinctively sparkling high-frequency range.
	DUAL	Allows you to use two reverbs simultaneously.
TERA ECO	This effect uses MDP technology to create a unique ambience and a spaciousness that changes according to your picking dynamics.	

COMMON

Parameter	Value	Explanation
TIME *1	0.1s–10.0s	Adjusts the length (time) of reverberation.
TONE	-50–0–+50	Adjusts the tonal character of the reverb.
DENSITY *1	1–10	Adjusts the density of the reverb sound.
E.LEVEL	0–100	Adjusts the volume of the reverb sound.
PRE-DELY *1	0ms–200ms	Adjusts the time until the reverb sound appears.
LO CUT *1	FLAT, 20.0Hz–20.0kHz	This sets the frequency at which the low cut filter begins to take effect. When FLAT is selected, the low cut filter will have no effect.
HI CUT *1	20.0Hz–20.0kHz, FLAT	This sets the frequency at which the high cut filter begins to take effect. When FLAT is selected, the high cut filter will have no effect.
LO DAMP *1	-50–0–+50	Adjusts the amount of attenuation for the low frequency region.
HI DAMP *1	-50–0–+50	Adjusts the amount of attenuation for the high frequency region.
MOD RATE *1	0–100	Adjusts the speed at which the reverb sound is modulated.
MOD DEPT *1	0–100	Adjusts the depth to which the reverb sound is modulated.
DUCK SNS *1	0–100	Adjusts the sensitivity at which the volume is automatically adjusted according to the input. Higher values allow the adjustment to occur in response to lower volumes.
DUCK PRE *1	0–100	When the input sound is loud, this automatically reduces the volume that is being input to the reverb and delay. As this setting approaches 100, the input volume reduction is applied more deeply.

Parameter	Value	Explanation
DUCK PST *1	0–100	When the input sound is loud, this automatically reduces the volume that is being output from the reverb and delay. As this setting approaches 100, the output volume reduction is applied more deeply.
D.LEVEL	0–100	Adjusts the volume of the direct sound.

*1 This is not shown if TYPE is set to TERA ECHO.



SHIMMER

Parameter	Value	Explanation
1:PITCH 2:PITCH	-24–+24	Adjusts the amount of pitch shift.
1:LEVEL 2:LEVEL	0–100	Adjusts the volume of the pitch shifter.

DUAL

Parameter	Value	Explanation
1:TYPE 2:TYPE	HALL, PLATE, ROOM	This selects the reverb type.
1:TIME 2:TIME	0.1–10.0s	Adjusts the length (time) of reverberation.
1:TONE 2:TONE	-50–+50	Adjusts the tonal character of the reverb.
1:LEVEL 2:LEVEL	0–100	Adjusts the volume of the reverb sound.
1:DENSTY 2:DENSTY	1–10	Adjusts the density of the reverb sound.
1:PRE-DL 2:PRE-DL	0ms–200ms	Adjusts the time until the reverb sound appears.
1:LO CUT 2:LO CUT	FLAT, 20.0Hz–20.0kHz	This sets the frequency at which the low cut filter begins to take effect. When FLAT is selected, the low cut filter will have no effect.
1:HI CUT 2:HI CUT	20.0Hz–20.0kHz, FLAT	This sets the frequency at which the high cut filter begins to take effect. When FLAT is selected, the high cut filter will have no effect.

TERA ECHO

Parameter	Value	Explanation
MODE	MONO 	Selects the mode of the effect sound. The L and R channels will both output the same sound.
	STEREO 1 	The R channel outputs the direct sound, and the L channel outputs the effect sound.
	STEREO2 	The effect is applied separately to the L and R channels.
SPREAD	0–100	Adjusts the length of the effect sound.
FEEDBACK	0–100	Adjusts the decay of the effect sound.
E.LEVEL	0–100	Adjusts the volume of the effect sound.
TONE	-50–+50	Adjusts the tone.
D.LEVEL	0–100	Adjusts the volume of the direct sound.
TRIGGER	OFF, ON	The effect sound is held when you turn this on. • Patches are written with the parameter set to Off.

PEDAL FX

MONO STEREO

You can control the wah effect or get a pitch bend effect in real time by adjusting the GT-1000CORE's expression pedal or the expression pedal connected to the CTL 2, 3/EXP 1 jack or CTL 4, 5/EXP 2 jack.

Parameter	Value	Explanation
ON/OFF	OFF, ON	Turns this effect on/off.
TYPE	PDL BEND	This lets you use the pedal to get a pitch bend effect. * Because of the need to analyze the pitch, chords (two or more sounds played simultaneously) cannot be played.
	WAH	You can control the wah effect in real time by adjusting the GT-1000CORE's expression pedal or the expression pedal connected to the CTL 2, 3/EXP 1 jack or CTL 4, 5/EXP 2 jack.

PEDAL BEND

MONO

Parameter	Value	Explanation
PITCH MIN	-24--+24	Specifies the pitch when the pedal is returned.
PITCH MAX	-24--+24	This sets the pitch at the point where the EXP Pedal is all the way down.
PDL POS	0-100	Adjusts the pedal position for pedal bend. This parameter is used after it's been assigned to an expression pedal or similar controller.
E.LEVEL	0-100	Adjusts the volume of the pitch bend sound.
DIR MIX	0-100	Adjusts the volume of the direct sound.

WAH

STEREO

Parameter	Value	Explanation
WAH TYPE		Selects the type of wah.
	CRY WAH	This models the sound of the CRY BABY wah pedal popular in the '70s.
	VO WAH	This models the sound of the VOX V846.
	FAT WAH	This is a wah sound featuring a bold tone.
	LIGHT WAH	This wah has a refined sound with no unusual characteristics.
	7STRING WAH	This expanded wah features a variable range compatible with seven-string and baritone guitars.
	RESO WAH	This completely original effect offers enhancements on the characteristic resonances produced by analog synth filters.
	BASS WAH	This wah has been specially adapted for use in the bass registers. Inclusion of the low-frequency range in the wah sound produces a robust wah effect, with no dilution of the sound.
PDL POS	0-100	Adjusts the position of the wah pedal. * This parameter is used after it's been assigned to an expression pedal or similar controller.
PDL MIN	0-100	Selects the tone produced when the heel of the EXP Pedal is depressed.
PDL MAX	0-100	Selects the tone produced when the toe of the EXP Pedal is depressed.
E.LEVEL	0-100	Adjusts the volume of the effect sound.
DIR MIX	0-100	Adjusts the volume of the direct sound.

FOOT VOLUME

STEREO

This is a volume control effect.

This is controlled with the expression pedal connected to the CTL 2, 3/EXP 1 jack or CTL 4, 5/EXP 2 jack.

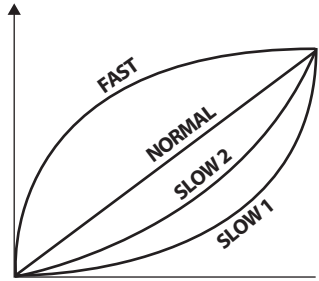
Parameter	Value	Explanation
PDL POS	0-100	Adjusts the volume.
VOL MIN	0-100	Sets the volume when the heel of the EXP Pedal is depressed.
VOL MAX	0-100	Selects the volume when the toe of the EXP Pedal is depressed.
CURVE		You can select how the actual volume changes relative to the amount the pedal is pressed. Volume
	SLOW1, SLOW2, NORMAL, FAST	 <p>When the pedal is fully raised When the pedal is fully advanced</p>

DIVIDER 1-3

STEREO

Within the effect chain, the point where the signal is split into channels "A" and "B" is called the "divider," and the point where the two signals are recombined is called the "mixer."

You can use the divider to switch between channels "A" and "B," to assign strongly picked notes and softly picked notes to different channels, or to assign different frequency bands of your guitar sound to different channels.

The mixer lets you adjust the volume balance of channels "A" and "B," place them in the stereo field, or slightly delay the sound of channel "B" to produce a spacious sound.

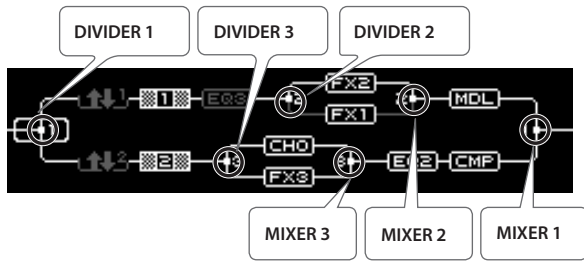

Parameter	Value	Explanation
MODE	SINGLE	Use only one channel, either "A" or "B."
	DUAL	Use the two channels "A" and "B."
ROUTING *1	STEREO	Inputs the INPUT L, R signals as a stereo signal in the chain.
	SELECTOR	If the plug is inserted into INPUT R only, the same signal passes through L and R.
CHANNEL *2	A, B	Inputs either the INPUT L or INPUT R signal by following the CHANNEL setting. This lets you plug different guitars into each of the two jacks and select which to use.
A:DYNAMIC *3 B:DYNAMIC *3	OFF	DYNAMIC will not be used.
	POLAR+ POLAR-	Only notes picked more strongly than the SENS setting will be output. Only notes picked more softly than the SENS setting will be output.
A:SENS *3 B:SENS *3	0-100	Specifies the picking sensitivity.
A:FILTER *3 B:FILTER *3	OFF	The filter will not be used.
	LPF	Only the region below the cutoff frequency will be output.
	HPF	Only the region above the cutoff frequency will be output.
A:CUTOFF *3 B:CUTOFF *3	100Hz, 125Hz, 160Hz, 200Hz, 250Hz, 315Hz, 400Hz, 500Hz, 630Hz, 800Hz, 1.00kHz, 1.25kHz, 1.60kHz, 2.00kHz, 2.50kHz, 3.15kHz, 4.00kHz	Cutoff frequency

*1 You can only select this when a divider is placed at the front of the chain.

*2 Setting available when MODE is set to SINGLE.

*3 Setting available when MODE is set to DUAL.

Exchanging the preamp settings between channels

Here's how to exchange the preamp settings between channels A and B.

1. Press the [EFFECT] button.
2. Turn knob [SELECT] to select the DIVIDER that you want to edit.
3. Press the [4] knob.

MIXER 1-3

STEREO

Parameter	Value	Explanation
MODE	STEREO	Channels "A" and "B" will be mixed and output in stereo.
	PAN L/R	Channels "A" and "B" will be assigned respectively to the L and R OUTPUT jacks.
A:LEVEL B:LEVEL	0-100	Adjusts the volume of the channel.
A/B BAL	100:0-0:100	Adjusts the volume balance of channels "A" and "B." * This is shown only if DIVIDER MODE is set to "DUAL."
SPREAD	0-100	Slightly delays the sound of channel "B" to make the sound more spacious. * This is shown only if DIVIDER MODE is set to "DUAL."

SEND/RETURN 1, 2

MONO

You can connect an external effects processor between the SEND jack and RETURN jack, and use it as one of the GT-1000CORE's effects processors.

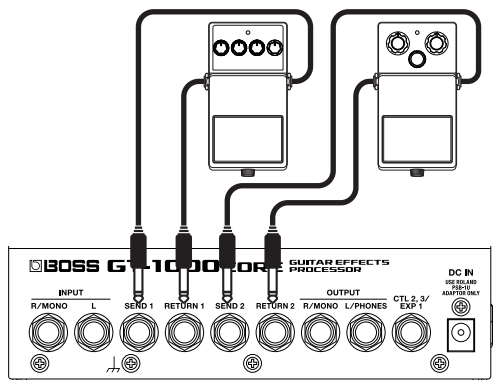

The sound that is input to SEND/RETURN within the effect chain will be output to the SEND jack. The sound that is input via the RETURN jack will be input to SEND/RETURN within the effect chain.

Parameter	Value	Explanation
ON/OFF	OFF, ON	Turns the SEND/RETURN on/off.
ST LINK	OFF, ON	If this is on, you can use the two sets of SEND and RETURN jacks to connect a stereo effect unit.
MODE	NORMAL	<p>The input to SEND/RETURN within the effect chain will be output to the SEND jack, and the input from the RETURN jack will be output following SEND/RETURN.</p> <p>Use this setting if you want to connect an external effects processor in series within the GT-1000CORE's effect chain.</p>
	DIRECT MIX	<p>The input to SEND/RETURN within the effect chain will be output to the SEND jack, and the input from the RETURN jack and the input to SEND/RETURN (the direct sound) will be mixed and output following SEND/RETURN.</p> <p>Use this when you want to mix the GT-1000CORE's effects sounds together with the sound with the external effects device applied to it.</p>
	BRANCH OUT	<p>The input to SEND/RETURN within the effect chain will be output to the SEND jack. The input from the RETURN jack will be ignored.</p> <p>For example, by placing SEND/RETURN in the GT-1000CORE's effect chain in front of reverb or delay, this allows you to use the SEND jack as a dry out.</p>
SEND	0-200	Adjusts the volume of the output to the external effects device.
RETURN	0-200	Adjusts the volume of the input from the external effects device. * You can adjust this if the MODE parameter is set to NORMAL or DIRECT MIX.

Parameter	Value	Explanation
ADJUST	0-100	Adjusts the phase between the GT-1000CORE's internal processing and an external effect unit connected to the SEND/RETURN jacks. You can adjust this if the MODE parameter is set to NORMAL or DIRECT MIX.

* The SEND/RETURN function is disabled if the SEND1 SETTING and SEND2 SETTING for MENU → HARDWARE SETTING → OTHER are not set to "SEND."

OUTPUT SP.SIMULATOR L, OUTPUT SP.SIMULATOR R, SUB OUT SP.SIMULATOR L, SUB OUT SP.SIMULATOR R

Parameter	Value	Explanation	
ST LINK	OFF, ON	If this is OFF, L and R can be independently positioned in the chain; if this is ON, they are positioned as a set (stereo).	
L:SP TYPE R:SP TYPE *1	Select the speaker type.		
	OFF	This turns off the speaker simulator.	
	ORIGINAL	This is the built-in speaker of the amp you selected with AIRD PREAMP TYPE.	
	1x8"	This is a compact open-back speaker cabinet with one 8-inch speaker.	
	1x10"	This is a compact open-back speaker cabinet with one 10-inch speaker.	
	1x12"	This is a compact open-back speaker cabinet with one standard 12-inch speaker.	
	1x12" 2	A Fender Deluxe Reverb cabinet. This is an open-back speaker cabinet with one Jensen C12K (12-inch) speaker.	
	2x12"	This is a general open-back speaker cabinet with two standard 12-inch speakers.	
	2x12" 2	A Roland JC-120 cabinet. This is an open-back speaker cabinet with two JC-120 original (12-inch) speakers.	
	2x12" 3	A Fender Twin Reverb cabinet. This is an open-back speaker cabinet with two Jensen C12K (12-inch) speakers.	
	2x12" 4	A VOX AC30 cabinet. This is an open-back speaker cabinet with two Celestion G12M Greenback (12-inch) speakers.	
	2x12" 5	A Matchless D/C-30 cabinet. This is an open-back speaker cabinet with two Matchless custom Celestion (12-inch) speakers.	
	4x10"	This is an optimal speaker cabinet for a large open-back with four standard 10-inch speakers.	
	4x10" 2	A Fender Bassman cabinet. This is an open-back speaker cabinet with four Jensen P10R (10-inch) speakers.	
	4x12"	This is an optimal speaker cabinet for a large enclosed amp with four standard 12-inch speakers.	
	4x12" 2	A Marshall 1960B cabinet. This is an enclosed amp speaker cabinet with four Celestion G12T-75 (12-inch) speakers.	
	4x12" 3	A Mesa Boogie Recto cabinet. This is an enclosed amp speaker cabinet with four Celestion Vintage 30 (12-inch) speakers.	
	4x12" 4	A ORANGE PPC412 cabinet. This is an enclosed amp speaker cabinet with four Celestion Vintage 30 (12-inch) speakers.	
	4x12" 5	A Bogner Ubercab cabinet. This is an enclosed amp speaker cabinet with four Celestion G12M Greenback (12-inch) speakers.	
	8x12"	This is a double stack of two cabinets, each with four 12-inch speakers.	
	B1x15"	This is a compact open-back speaker cabinet with one 15-inch speaker.	
	B1x18"	This is a compact open-back speaker cabinet with one 18-inch speaker.	
	B2x15"	This is a general open-back speaker cabinet with two 15-inch speakers.	
	B4x10"	This is an optimal speaker cabinet for a large enclosed amp with four 10-inch speakers.	
	B8x10"	This is a double stack of two cabinets, each with four 10-inch speakers.	
	USER1-16	You can create an original SP TYPE by using a dedicated tool to load IR (Impulse Response) data into the GT-1000CORE. Download the dedicated tool from the BOSS website. http://www.boss.info/support/	

Parameter	Value	Explanation
L:MIC TYP R:MIC TYP *2	This setting selects the simulated mic type.	
	DYN57	This is the sound of the SHURE SM-57. General dynamic mic used for instruments and vocals. Optimal for use in miking guitar amps.
	DYN421	This is the sound of the SENNHEISER MD-421. Dynamic mic with extended low end.
	CND451	This is the sound of the AKG C451B. Small condenser mic for use with instruments.
	CND87	This is the sound of the NEUMANN U87. Condenser mic with flat response.
	RBN121	Simulates the sound of the ROYER R-121. Warm and natural ribbon mic sound.
	BLEND A	Simulates the blended sound of the SHURE SM57 and ROYER R-121, with the SM57 mixed at a higher level.
	BLEND B	Simulates the blended sound of the SHURE SM57 and ROYER R-121, with the mics mixed at equal levels.
	BLEND C	Simulates the blended sound of the SHURE SM57 and ROYER R-121, with the R-121 mixed at a higher level.
	FLAT	Simulates a mic with perfectly flat response. Produces a sonic image close to that of listening to the sound directly from the speakers (on site).
	L:MIC DST R:MIC DST *2	SHORT, MEDIUM, LONG
L:MIC POS R:MIC POS *2	This simulates the mic position.	
	CENTER	Simulates the condition that the mic is set in the middle of the speaker cone.
	1cm-10cm	Simulates the condition that the mic is moved away from the center of the speaker cone.
L:MIC LVL R:MIC LVL *2	0-100	Adjusts the volume of the mic.
L:DIR MIX R:DIR MIX *2	0-100	Adjusts the volume of the direct sound.

*1 This is shown only if OUTPUT SELECT is set to "RECORDING."

*2 This is shown only if OUTPUT SELECT is set to "LINE/PHONES" or "RECORDING."

MASTER

These settings are applied to the overall patch.

Parameter	Value	Explanation
PATCH LV	0–200	Adjusts the volume of the patch.
BPM	40–250	Adjusts the BPM value for each patch. * BPM (beats per minute) indicates the number of quarter note beats that occur each minute
KEY	C (Am)– B (G#m)	This sets the key for the FX HARMONIST. Major C F B ^b E ^b A ^b D ^b Minor A ^m D ^m G ^m C ^m F ^m B ^b ^m Major C G D A E B F [#] Minor A ^m E ^m B ^m F [#] ^m C ^m G [#] ^m D ^m

By connecting your guitar amp's channel switching jack to the GT-1000CORE's CTL 4, CTL 5 jacks, you can then use CTL 4, CTL 5 to switch the amp channel. This combining of the GT-1000CORE and the amp channels allows you to get an even wider variety of distortion sounds.

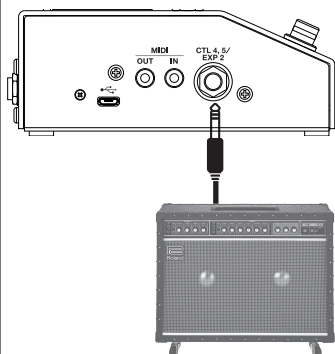

* To control a guitar amp or other external device, set the MENU → HARDWARE SETTING → OTHER → CTL 4, 5 SETTING to AMP CTL.

* The on/off state of the CTL jack is saved as an effect parameter for each patch, and you can switch the guitar amp channel for each patch.

AMP CTL1
AMP CTL2

OFF

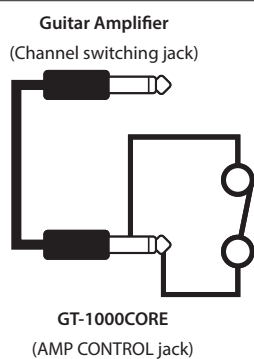

ON

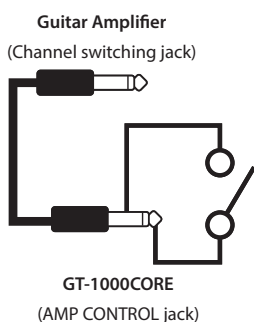

CARRYOVR

OFF, ON

You can specify whether the effect sound is carried-over when you switch patches.

Parameter	Value	Explanation
BS MODE	OFF, ON	If this is ON, effects that affect the pitch are optimized for bass.
INPUT	SYSTEM, 1–10	Selects the guitar (input level) that is connected to the INPUT jack. This lets you specify for each patch the guitar that will be connected. If you select SYSTEM, the settings of "INPUT" (p. 44) are used.

CONTROL MODE

The control mode setting lets you choose how you want to operate the effects.

Parameter	Explanation
MEMORY (Memory mode)	<p>This mode lets you recall and use the patches that are saved in the unit.</p> <p>Use [▼][▲] switches to switch patches.</p> <ul style="list-style-type: none"> * Press the [▲] and [CTL1] switches together to switch to manual mode. * Press the [▼] and [▲] switches together to start the tuner.
MANUAL (Manual mode)	<p>This mode lets you use [▼][▲] switches to operate the functions that are assigned to them by each patch or by the settings for the entire system.</p> <p>When you select manual mode, a portion of the PLAY screen changes.</p> 

CONTROL ASSIGN

CONTROL FUNCTION

Here you can specify the parameters that are controlled by all of the top panel footswitches, and expression pedals or footswitches that are connected to the rear panel CTL2, 3/EXP1 jack and the side panel CTL4, 5/EXP2 jack.

FUNCTION ([▼] switch, [▲] switch, [CTL1] switch, , CTL2–5, MAN▼, MAN▲)

Value	Explanation
OFF	No assignment.
PATCH +1	*1 Switches to the next patch number.
PATCH -1	*1 Switches to the previous patch number.
LEVEL +10	Increases the patch volume level by 10 units.
LEVEL +20	Increases the patch volume level by 20 units.
LEVEL -10	Decreases the patch volume level by 10 units.
LEVEL -20	Decreases the patch volume level by 20 units.
BPM TAP	Used for tap input of the MASTER BPM.
DLY1 TAP	Used for tap input of the DELAY 1.
DLY2 TAP	Used for tap input of the DELAY 2.
DLY3 TAP	Used for tap input of the DELAY 3.
DLY4 TAP	Used for tap input of the DELAY 4.
MST DLY TAP	Used for tap input of the MASTER DELAY.
TUNER	Switches the TUNER on and off.
MANUAL	Switches the MANUAL on and off.
TUNE/MAN	Turns TUNER on/off when briefly pressed; turns MANUAL on/off when long-pressed.
MAN/TUNE	Turns MANUAL on/off when briefly pressed; turns TUNER on/off when long-pressed.
AMP CTL 1	*2 Switches the AMP CTL 1 on and off.
AMP CTL 2	*2 Switches the AMP CTL 2 on and off.
CMP	Switches the COMPRESSOR on and off.
DS1	Switches the DISTORTION 1 on and off.
DS1 SOLO	Switches the DISTORTION 1 SOLO on and off.
DS2	Switches the DISTORTION 2 on and off.
DS2 SOLO	Switches the DISTORTION 2 SOLO on and off.
AMP1	Switches the AIRD PREAMP 1 on and off.
AMP1SOLO	Switches the AIRD PREAMP 1 SOLO on and off.
AMP2	Switches the AIRD PREAMP 2 on and off.
AMP2SOLO	Switches the AIRD PREAMP 2 SOLO on and off.
NS 1	Switches the NOISE SUPPRESSOR 1 on and off.
NS 2	Switches the NOISE SUPPRESSOR 2 on and off.
EQ 1	Switches the EQUALIZER 1 on and off.
EQ 2	Switches the EQUALIZER 2 on and off.
EQ 3	Switches the EQUALIZER 3 on and off.
EQ 4	Switches the EQUALIZER 4 on and off.
DLY1	Switches the DELAY 1 on and off.
DLY2	Switches the DELAY 2 on and off.
DLY3	Switches the DELAY 3 on and off.
DLY4	Switches the DELAY 4 on and off.
MST DLY	Switches the MASTER DELAY on and off.
CHO	Switches the CHORUS on and off.
FX1	Switches the FX1 on and off.
FX2	Switches the FX2 on and off.
FX3	Switches the FX3 on and off.
FX1 TRIGGER	Switches the FX1 TRIGGER on and off.
FX2 TRIGGER	Switches the FX2 TRIGGER on and off.
FX3 TRIGGER	Switches the FX3 TRIGGER on and off.

Value	Explanation
MDLY TRIG	Turns the trigger on/off when the MASTER DELAY's TYPE is WARP or TWIST.
REV	Switches the REVERB on and off.
PFX	Switches the PEDAL FX on and off.
DIV1 CH	Switches the DIVIDER 1 channel select.
DIV2 CH	Switches the DIVIDER 2 channel select.
DIV3 CH	Switches the DIVIDER 3 channel select.
S/R1	Switches the SEND/RETURN 1 on and off.
S/R2	Switches the SEND/RETURN 2 on and off.
LOOPER	Controls the looper. For details on operation, refer to "Looper" (owner's manual).
LP STOP	Stops the phrase.
LP CLEAR	Clears the phrase
METRO	Turns the metronome on/off.
MIDI START	Controls the Start/Stop of external MIDI devices (such as sequencers).
MMC PLAY	Controls the Play/Stop of external MIDI devices (such as hard disk recorders).

*1 Not shown in "CUR NUM" and "MANUAL 1-5"

*2 When using AMP CTL, set the MENU → HARDWARE SETTING → OTHER → CTL 4, 5 SETTING to AMP CTL.

FUNCTION (EXP1, EXP 2)

Value	Explanation
OFF	No assignment.
FOOT VOL	Foot volume will be assigned.
PEDAL FX	PEDAL FX will be assigned. According to the pedal effect setting, this operates as wah or as pedal bend.
FV/PD FX	PEDAL FX and foot volume will be assigned.
FV+TUNER	Foot volume will be assigned. TUNER is displayed if the pedal is returned all the way.
FVTU/PFX	PEDAL FX and foot volume will be assigned. TUNER is displayed if the pedal is returned all the way when using foot volume.

MODE

Value	Explanation
TOGGLE	The setting is toggled On (maximum value) or Off (minimum value) with each press of the footswitch.
MOMENT	The normal state is Off (minimum value), with the switch On (maximum value) only while the footswitch is depressed.

PREFERENCE







Value	Explanation
PATCH	Different settings can be made independently for each patch.
SYSTEM	The same settings will be shared by all patches.

ASSIGN SETTING

ASSIGN 1-16

For each parameter, you can specify, in detail, which controller will control which parameter. You can create 16 sets of such assignments.

Parameter	Value	Explanation	
SW	OFF, ON	Turns the ASSIGN 1-16 on/off.	
TARGET	TARGET	This selects the parameter to be changed. Refer to "TARGET list" (p. 35).	
	MIN	This sets the minimum value for the range in which the parameter can change. The value differs depending on the parameter assigned for TARGET parameter.	
	MAX	This sets the maximum value for the range in which the parameter can change. The value differs depending on the parameter assigned for TARGET parameter.	
SOURCE	▼, ▲, CTL1	Assigns the GT-1000CORE's footswitch.	
	CTL2, CTL3	Assigns the external footswitch connected to the CTL 2, 3/ EXP 1 jack.	
	CTL4, CTL5	Assigns the external footswitch connected to the CTL 4, 5/ EXP 2 jack.	
	EXP1	Assigns the external expression pedal connected to the CTL 2, 3/ EXP 1 jack.	
	EXP2	Assigns the external expression pedal connected to the CTL 4, 5/ EXP 2 jack.	
	INT PEDAL	Assigns the internal pedal.	Refer to "Virtual Expression Pedal (Internal Pedal / Wave Pedal)" (p. 42).
	WAVE PDL	Assigns the wave pedal.	
	INPUT	The assigned target parameter will change according to the input level.	
	CC#1-31, 64-95	Control Change messages from an external MIDI device.	
	MODE	MOMENT	The normal state is Off (minimum value), with the switch On (maximum value) only while the footswitch is depressed.
TOGGLE		The setting is toggled On (maximum value) or Off (minimum value) with each press of the footswitch.	
ACT LOW		0-126	You can set the controllable range for target parameters within the source's operational range. Target parameters are controlled within the range set with ACT LOW and ACT HIGH. You should normally set ACT LOW to 0 and ACT HIGH to 127.
ACT HIGH	1-127		
INPUT	SENS	0-100	This adjusts the input sensitivity when INPUT is selected for SOURCE.

Parameter	Value	Explanation	
INTERNAL PEDAL	TRIGGER *1	PATCH	This is activated when a patch is selected.
		▼, ▲, CTL1	This is activated when the GT-1000CORE's footswitch is operated.
		EXP1	This is activated when an external expression pedal connected to the CTL 2, 3/ EXP 1 jack.
		EXP2	This is activated when an external expression pedal connected to the CTL 4, 5/ EXP 2 jack.
		CTL2, CTL3	This is activated when an external footswitch connected to the CTL 2, 3/ EXP 1 jack is operated.
		CTL4, CTL5	This is activated when an external footswitch connected to the CTL 4, 5/ EXP 2 jack is operated.
		CC#1–31, 64–95	This is activated when a control change is received.
	TIME *1	0–100	This specifies the time over which the internal pedal will move from the toe-raised position to the toe-down position.
	CURVE *1	LINEAR	
		SLOW RISE	
FAST RISE			
WAVE PEDAL	FORM *2	SAW	
		TRI	
		SINE	
	RATE *2	0–100, BPM 	This determines the time spend for one cycle of the assumed EXP Pedal. * When set to BPM, the value of each parameter will be set according to the value of the "MASTER BPM" specified for each patch. This makes it easier to achieve effect sound settings that match the tempo of the song. * If, due to the tempo, the time is longer than the range of allowable settings, it is then synchronized to a period either 1/2 or 1/4 of that time.
MIDI	CH *3 *4	SYSTEM	This transmits a message on the MIDI channel specified by the "MIDI SETTING" (p. 47) parameter TX CHANNEL.
		1–16	The message is transmitted on the specified MIDI channel.
TARGET MIDI CC# *3	CC#	0–127	The message is transmitted using the specified controller number.
	MIN	0–127	Selects the minimum value of the transmitted CC# message.
	MAX	0–127	Selects the maximum value of the transmitted CC# message.
TARGET MIDI PC# *4	PC#	1–128	Specifies the program number that is transmitted.
	MSB	OFF, 0–127	Specifies the bank select MSB that is transmitted. If this is OFF, the bank select MSB is not transmitted.
	LSB	OFF, 0–127	Specifies the bank select MSB that is transmitted. If this is OFF, the bank select LSB is not transmitted.

*1 The INTERNAL PEDAL TRIGGER, INTERNAL PEDAL TIME, and INTERNAL PEDAL CURVE parameters are enabled when the SOURCE parameter is set to INT PEDAL.

*2 The WAVE PEDAL FORM and WAVE PEDAL RATE parameters are enabled when the Source parameter is set to WAVE PEDAL.

*3 The MIDI CH, TARGET MIDI CC# parameters are enabled when the TARGET is set to MIDI CC.

*4 The MIDI CH, TARGET MIDI PC# parameters are enabled when the TARGET is set to MIDI PC.

TARGET list

CATEGORY	TARGET	Value
COMP (COMPRESSOR)	ON/OFF	OFF, ON
	TYPE	BOSS CMP (BOSS COMP), X-COMP, D-COMP, ORANGE, STEREO (STEREO COMP), X-BASS (X-BASS COMP)
	SUSTAIN	0-100
	ATTACK	0-100
	RATIO	1:1, 1.2:1, 1.4:1, 1.6:1, 1.8:1, 2:1, 2.3:1, 2.6:1, 3:1, 3.5:1, 4:1, 5:1, 6:1, 8:1, 10:1, 12:1, 20:1, INF:1
	TONE	-50-0-+50
	LEVEL	0-100
	DIRECT MIX	0-100
CMP:BASS (COMPRESSOR BASS)	THRESHOLD	0-100
DIST 1 (DISTORTION 1) DIST 2 (DISTORTION 2)	ON/OFF	OFF, ON
	TYPE	MID (MID BOOST), CLEAN (CLEAN BOOST), TREBLE (TREBLE BOOST), CRUNCH, NATURAL (NATURAL OD), WARM OD, FAT DS, LEAD DS, METAL DS, OCT FUZZ, A-DIST, X-OD, X-DIST, BLUES OD, OD-1, SD-1, T-SCREAM, TURBO OD, DIST, DS-1, CENTA OD, RAT, GUV DS, DIST+, MTL ZONE (METAL ZONE), HM-2, MTL CORE (METAL CORE), 60S FUZZ (60S FUZZ), MUFF FUZ (MUFF FUZZ), BASS OD, BASS DS, BASS MT, BASS FUZ (BASS FUZZ), HI BAND (HI BAND DRIVE), X-BASS (X-BASS OD), BASS DRV, BASS DI
	DRIVE	0-120
	TONE	-50-0-+50
	E.LEVEL	0-100
	BOTTOM	-50-0-+50
	DIR MIX	0-100
	SOLO SW	OFF, ON
	SOLO LEVEL	0-100

CATEGORY	TARGET	Value
PREAMP 1 (AIRD PREAMP 1) PREAMP 2 (AIRD PREAMP 2)	ON/OFF	OFF, ON
	TYPE	TRNSPRNT (TRANSPARENT), NATURAL, BOUTIQUE, SUPREME, MAXIMUM, JUGGERNT (JUGGERNAUT), X-CRUNCH, X-HI GAIN, X-MODDED, X-ULTRA, X-OPTIMA, X-TITAN, JC-120, TWIN (TWIN COMBO), DELUXE (DELUXE COMBO), TWEED (TWEED COMBO), DIAMOND (DIAMOND AMP), BRIT STK (BRIT STACK), RECTI STK (RECTI STACK), MATCH (MATCH COMBO), BG COMBO, ORNG STK (ORNG STACK), BGNR UB (BGNR UB METAL), NATRL BS (NATURAL BASS), X-DRV BS (X-DRIVE BASS), CONCERT, STUDIO BS (STUDIO BASS), SILVER (SILVER TUBE), CL BLUE (CLASSIC BLUE), SOLID STK (SOLID STACK), FAT TUBE, DARK DRV
	GAIN	0-120
	SAG	-10-0-+10
	RESONANCE	-10-0-+10
	BASS	0-100
	MIDDLE	0-100
	TREBLE	0-100
	PRESENCE	0-100
	BRIGHT	OFF, ON
	GAIN SW	LOW, MIDDLE, HIGH
	LEVEL	0-100
	SOLO SW	OFF, ON
	SOLO LEVEL	0-100
	NS 1 (NOISE SUPPRESSOR 1) NS 2 (NOISE SUPPRESSOR 2)	ON/OFF
THRESHOLD		0-100
RELEASE		0-100
EQ 1 (EQUALIZER 1) EQ 2 (EQUALIZER 2) EQ 3 (EQUALIZER 3) EQ 4 (EQUALIZER 4)	DETECT	INPUT, NS INPUT, FV OUT
	ON/OFF	OFF, ON
PEQ 1 (EQUALIZER 1 PARAMETRIC) PEQ 2 (EQUALIZER 2 PARAMETRIC) PEQ 3 (EQUALIZER 3 PARAMETRIC) PEQ 4 (EQUALIZER 4 PARAMETRIC)	TYPE	PARAMTRC (PARAMETRIC), GRAPHIC
	LO GAIN	-20dB -0dB-+20dB
	LM FREQ	20.0Hz--16.0kHz
	LM Q	0.5, 1, 2, 4, 8, 16
	LM GAIN	-20dB - 0dB - +20dB
	HM FREQ	20.0Hz - 16.0kHz
	HM Q	0.5, 1, 2, 4, 8, 16
	HM GAIN	-20dB -0dB-+20dB
	HI GAIN	-20dB -0dB-+20dB
	LEVEL	-20dB -0dB-+20dB
	LO CUT	FLAT, 20.0Hz - 20.0kHz
	HI CUT	20.0Hz - 20.0kHz, FLAT

CATEGORY	TARGET	Value	
GEQ 1 (EQUALIZER 1 GRAPHIC) GEQ 2 (EQUALIZER 2 GRAPHIC) GEQ 3 (EQUALIZER 3 GRAPHIC) GEQ 4 (EQUALIZER 4 GRAPHIC)	31.5Hz	-20dB -0dB +20dB	
	63Hz	-20dB -0dB +20dB	
	125Hz	-20dB -0dB +20dB	
	250Hz	-20dB -0dB +20dB	
	500Hz	-20dB -0dB +20dB	
	1kHz	-20dB -0dB +20dB	
	2kHz	-20dB -0dB +20dB	
	4kHz	-20dB -0dB +20dB	
DELAY 1 DELAY 2 DELAY 3 DELAY 4	8kHz	-20dB -0dB +20dB	
	16kHz	-20dB -0dB +20dB	
	LEVEL	-20dB -0dB +20dB	
	ON/OFF	OFF, ON	
	TIME	1ms-2000ms, BPM $\frac{1}{2}$ - ∞	
MDLY (MASTER DELAY)	FEEDBACK	0-100	
	HI CUT	20.0Hz-20.0kHz, FLAT	
	E.LEVEL	0-120	
	D.LEVEL	0-100	
	MOD RATE	0-100	
	MOD DEPTH	0-100	
	DUCK SENS	0-100	
	DUCK PRE DEPTH	0-100	
	DUCK POST DEPTH	0-100	
	PAN TAP TIME	0%-100%	
	TRIGGER	OFF, ON	
	LEVEL	0-100	
	AUTO TRIG	OFF, ON	
	MDLY:TAPE (MASTER DELAY:TAPE)	HEAD	1, 1+2, 1+3, 2+3, 1+2+3
	MDLY:SHIMR (MASTER DELAY:SHIMMER)	PITCH	-24 -0 +24
PITCH BAL		0-100	
PITCH FBK		0-100	

CATEGORY	TARGET	Value
MDLY:DUAL (MASTER DELAY:DUAL)	MODE	SERIES, PARALLEL, L/R
	1:TYPE	MONO, PAN, ANALOG, TAPE
	2:TYPE	
	1:TIME	1ms-2000ms, BPM $\frac{1}{2}$ - ∞
	2:TIME	
	1:FEEDBK (1:FEEDBACK)	0-100
	2:FEEDBK (2:FEEDBACK)	
	1:HI CUT (1:HIGH CUT)	20.0Hz-20.0kHz, FLAT
2:HI CUT (2:HIGH CUT)		
MDLY:TWIST (MASTER DELAY:TWIST)	1:E.LEVEL (1:EFFECT LEVEL)	0-120
	2:E.LEVEL (2:EFFECT LEVEL)	
	MODE	FALL (RISE->FALL), FADE (RISE->FADE)
	RISE TIME	0-100
MDLY:GLT (MASTER DELAY:CLITCH)	FALL TIME	0-100
	FADE TIME	0-100
	DUTY	0-100
M-DLY:ECHO (MASTER DELAY ECHO)	WOW & FLUTTER	0-100
	SPACE HEAD	1, 1+2, 1+3, 2+3, 1+2+3
	BINDRM HEAD (BINDRUM HEAD)	1, 2, 3, 4, 1+2, 2+3, 3+4, 1+3, 2+4, 1+2+3, 2+3+4, 1+2+3+4
	SELECTOR	ECHO, REPEAT, SWELL
MDLY:SDE (MASTER DELAY:SDE-3000)	FIL (FILTER)	OFF, ON
	TIME2 (TIMEx2)	OFF, ON
	DL PH (DELAY PHASE)	NORMAL, INVERT
MDLY:DD20 (MASTER DELAY:DD-20)	FB PH (FEEDBACK PHASE)	NORMAL, INVERT
	TONE	0-100
CHORUS	ON/OFF	OFF, ON
	TYPE	MONO, STEREO 1, STEREO 2, DUAL
	RATE	0-100, BPM $\frac{1}{2}$ - ∞
	DEPTH	0-100
	PRE-DELAY	0.0ms-40.0ms
	WAVEFORM	TRI, SINE
	E.LEVEL	0-100
	D.LEVEL	0-100
	LO CUT	FLAT, 20.0Hz-20.0kHz
	HI CUT	20.0Hz-20.0kHz, FLAT
CHO:DUAL (CHORUS: DUAL)	1:RATE	0-100, BPM $\frac{1}{2}$ - ∞
	2:RATE	
	1:DEPTH	0-100
	2:DEPTH	
	1:PRE-DLY (1:PRE-DELAY)	0.0ms-40.0ms
	2:PRE-DLY (2:PRE-DELAY)	
	1:WAVEFORM	TRI, SINE
	2:WAVEFORM	
	1:E.LEVEL (1:EFFECT LEVEL)	0-100
	2:E.LEVEL (2:EFFECT LEVEL)	
CHO:DUAL (CHORUS: DUAL)	1:LO CUT (1:LOW CUT)	FLAT, 20.0Hz-20.0kHz
	2:LO CUT (2:LOW CUT)	
	1:HI CUT (1:HIGH CUT)	20.0Hz-20.0kHz, FLAT
	2:HI CUT (2:HIGH CUT)	
OUTPUT (OUTPUT MODE)	MONO, STEREO	

CATEGORY	TARGET	Value
FX1 FX2 FX3	ON/OFF	OFF, ON
	TYPE	AC.G SIM (AC GUITAR SIM), AC RESO (AC RESONANCE), AUTO WAH, CHORUS, CHO BASS (CHORUS BASS), C-VIBE (CLASSIC-VIBE), COMP (COMPRESSOR), DEFRETR (DEFRETTER), DEFRET B (DEFRETTER BASS), DIST (DISTORTION), FEEDBAKR (FEEDBACKER), FLANGER, FLANGR B (FLANGER BASS), HARMONST (HARMONIST), HUMANIZR (HUMANIZER), MST.FX (MASTERING FX), OCTAVE, OCT BASS (OCTAVE BASS), OVERTONE, PAN, PHASER, PITCH SFT (PITCH SHIFTER), RING MOD, ROTARY, SITAR SIM, SLICER, SLW GEAR (SLOW GEAR), SG BASS (SLOW GEAR BASS), SND HOLD (SOUND HOLD), S-BEND, TOUCH WH (TOUCH WAH), TW BASS (TOUCH WAH BASS), TREMOLO, VIBRATO
FX1:AcGTR SIM (FX1:AC.GUITAR SIMULATOR)	BODY	0-100
FX2:AcGTR SIM (FX2:AC.GUITAR SIMULATOR)	LO	-50-0-+50
FX3:AcGTR SIM (FX3:AC.GUITAR SIMULATOR)	HI	-50-0-+50
FX1:AcRESO (FX1:AC RESONANCE)	LEVEL	0-100
FX2:AcRESO (FX2:AC RESONANCE)	TYPE	NATURAL, WIDE, BRIGHT
FX3:AcRESO (FX3:AC RESONANCE)	RESO	0-100
	TONE	-50-0-+50
	LEVEL	0-100
FX1:AW (FX1:AUTO WAH) FX2:AW (FX1:AUTO WAH) FX3:AW (FX1:AUTO WAH)	FILTER MODE	LPF, BPF, HPF
	RATE	0-100, BPM
	DEPTH	0-100
	E.LEVEL	0-100
	FREQUENCY	0-100
	RESONANCE	0-100
	WAVEFORM	TRI, SINE
	DIR MIX	0-100

CATEGORY	TARGET	Value
FX1:CHO (FX1:CHORUS) FX2:CHO (FX2:CHORUS) FX3:CHO (FX3:CHORUS)	TYPE	MONO, STEREO 1, STEREO 2, DUAL, PRIME, CE-1 CHO, CE-1 VIB
	RATE	0-100, BPM
	DEPTH	0-100
	PRE-DELAY	0.0ms-40.0ms
	WAVEFORM	TRI, SINE
	E.LEVEL	0-100
	D.LEVEL	0-100
	LO CUT	FLAT, 20.0Hz-20.0kHz
	HI CUT	20.0Hz-20.0kHz, FLAT
	OUTPUT MODE	MONO, STEREO
	DUAL 1:RATE DUAL 2:RATE	0-100, BPM
	DUAL 1:DEPT (1:DEPTH) DUAL 2:DEPT (2:DEPTH)	0-100
	DUAL 1:PrDL (1:PRE- DELAY) DUAL 2:PrDL (2:PRE- DELAY)	0.0ms-40.0ms
	DUAL 1:WAVE (1:WAVEFORM) DUAL 2:WAVE (2:WAVEFORM)	TRI, SINE
	DUAL 1:E.LV (1:EFFECT LEVEL) DUAL 2:E.LV (2:EFFECT LEVEL)	0-100
	DUAL 1:L.CUT (1:LOW CUT) DUAL 2:L.CUT (2:LOW CUT)	FLAT, 20.0Hz-20.0kHz
	DUAL 1:H.CUT (1:HIGH CUT) DUAL 2:H.CUT (2:HIGH CUT)	20.0Hz-20.0kHz, FLAT
	PRIME SWEETNESS	0-100
	PRIME BELL	0-100
	CE1 PREAMP (CE-1 PREAMP SW)	OFF, ON
CE1 PrA GAIN (CE-1 PREAMP GAIN)	0-100	
CE1 PrA LVL (CE-1 PREAMP LEVEL)	0-100	
FX1:CHO BS (FX1:CHORUS BASS) FX2:CHO BS (FX2:CHORUS BASS) FX3:CHO BS (FX3:CHORUS BASS)	TYPE	MONO, STEREO 1, STEREO 2
	RATE	0-100, BPM
	DEPTH	0-100
	E.LEVEL	0-100
	LO CUT	FLAT, 20.0Hz-20.0kHz
HI CUT	20.0Hz-20.0kHz, FLAT	
FX1:C-VIBE (FX1:CLASSIC-VIBE) FX2:C-VIBE (FX2:CLASSIC-VIBE) FX3:C-VIBE (FX3:CLASSIC-VIBE)	MODE	CHORUS, VIBRATO
	RATE	0-100, BPM
	DEPTH	0-100
	E.LEVEL	0-100

CATEGORY	TARGET	Value
FX1:COMP (COMPRESSOR) FX2:COMP (COMPRESSOR) FX3:COMP (COMPRESSOR) FX4:COMP (COMPRESSOR)	TYPE	BOSS CMP (BOSS COMP), X-COMP, D-COMP, ORANGE, STEREO (STEREO COMP), X-BASS (X-BASS COMP)
	SUSTAIN	0-100
	ATTACK	0-100
	RATIO	1:1, 1.2:1, 1.4:1, 1.6:1, 1.8:1, 2:1, 2.3:1, 2.6:1, 3:1, 3.5:1, 4:1, 5:1, 6:1, 8:1, 10:1, 12:1, 20:1, INF:1
	TONE	-50+50
	LEVEL	0-100
	DIR MIX	0-100
FX1:COMP BS (FX1:COMPRESSOR BASS) FX2:COMP BS (FX2:COMPRESSOR BASS) FX3:COMP BS (FX3:COMPRESSOR BASS)	THRESHOLD	0-100
FX1:DEFRET (FX1:DEFRETTER) FX2:DEFRET (FX2:DEFRETTER) FX3:DEFRET (FX3:DEFRETTER)	SENS	0-100
	DEPTH	0-100
	ATTACK	0-100
	RESONANCE	0-100
	TONE	-50+50
	E.LEVEL	0-100
FX1:DFRET B (FX1:DEFRETTER BASS) FX2:DFRET B (FX2:DEFRETTER BASS) FX3:DFRET B (FX3:DEFRETTER BASS)	SENS	0-100
	ATTACK	0-100
	TONE	-50+50
	E.LEVEL	0-100
FX1:DIST (FX1:DISTORTION) FX2:DIST (FX2:DISTORTION) FX3:DIST (FX3:DISTORTION)	TYPE	MID (MID BOOST), CLEAN (CLEAN BOOST), TREBLE (TREBLE BOOST), CRUNCH, NATURAL (NATURAL OD), WARM OD, FAT DS, LEAD DS, METAL DS, OCT FUZZ, A-DIST, X-OD, X-DIST, BLUES OD, OD-1, SD-1, T-SCREAM, TURBO OD, DIST, DS-1, CENTA OD, RAT, GUV DS, DIST+, MTL ZONE (METAL ZONE), HM-2, MTL CORE (METAL CORE), 60S FUZZ ('60S FUZZ), MUFF FUZ (MUFF FUZZ), BASS OD, BASS DS, BASS MT, BASS FUZ (BASS FUZZ), HI BAND (HI BAND DRIVE), X-BASS (X-BASS OD), BASS DRV, BASS DI
	DRIVE	0-120
	TONE	-50+50
	E.LEVEL	0-100
	BOTTOM	-50+50
	DIR MIX	0-100
	SOLO SW	OFF, ON
	SOLO LEVEL	0-100

CATEGORY	TARGET	Value
FX1:FEEDBK (FX1:FEEDBACKER) FX2:FEEDBK (FX2:FEEDBACKER) FX3:FEEDBK (FX3:FEEDBACKER)	MODE	NORMAL, OSC
	TRIGGER	OFF, ON
	DEPTH	0-100
	RISE TIME	0-100
	OCT RISE (OCTAVE RISE TIME)	0-100
	FEEDBK (FEEDBACK)	0-100
	OCT FBK (OCTAVE FEEDBACK)	0-100
	VIB RATE (VIBRATO RATE)	0-100
FX1:FLANG (FX1:FLANGER) FX2:FLANG (FX2:FLANGER) FX3:FLANG (FX3:FLANGER)	VIB DEPT (VIBRATO DEPTH)	0-100
	RATE	0-100, BPM
	DEPTH	0-100
	RESONANCE	0-100
	MANUAL	0-100
	TURBO	OFF, ON
	WAVEFORM	TRI, SINE
	STEPRATE	0-100, BPM
	SEPARATION	0-180
	E.LEVEL	0-100
FX1:FLNG B (FX1:FLANGER BASS) FX2:FLNG B (FX2:FLANGER BASS) FX3:FLNG B (FX3:FLANGER BASS)	LO DAMP	-100-0
	HI DAMP	-100-0
	LO CUT	FLAT, 20.0Hz-20.0kHz
	HI CUT	20.0Hz-20.0kHz, FLAT
	DIR MIX	0-100
	RATE	0-100, BPM
	DEPTH	0-100
	RESONANCE	0-100
	MANUAL	0-100
	TURBO	OFF, ON
FX1:FLNG B (FX1:FLANGER BASS) FX2:FLNG B (FX2:FLANGER BASS) FX3:FLNG B (FX3:FLANGER BASS)	WAVEFORM	TRI, SINE
	STEPRATE	0-100, BPM
	SEPARATION	0-180
	E.LEVEL	0-100
	LOW DAMP	-100-0
	HIGH DAMP	-100-0
	LO CUT	FLAT, 20.0Hz-20.0kHz
	HI CUT	20.0Hz-20.0kHz, FLAT
	DIR MIX	0-100

CATEGORY	TARGET	Value
FX1:HARMO (FX1:HARMONIST) FX2:HARMO (FX2:HARMONIST) FX3:HARMO (FX3:HARMONIST)	VOICE	1VOICE, 2MONO, 2STEREO
	1:HARMO (1:HARMONY) 2:HARMO (2:HARMONY)	-2oct, -14th, -13th, -12th, -11th, -10th, -9th, -1oct, -7th, -6th, -5th, -4th, -3rd, -2nd, UNISON, +2nd, +3rd, +4th, +5th, +6th, +7th, +1oct, +9th, +10th, +11th, +12th, +13th, +14th, +2oct, USER
	1:PRE-DLY (1:PRE-DELAY) 2:PRE-DLY (2:PRE-DELAY)	0-300ms, BPM $\frac{1}{2}$ - $\frac{1}{4}$
	1:FEEDBK (1:FEEDBACK) 2:FEEDBK (2:FEEDBACK)	0-100
	1:LEVEL 2:LEVEL	0-100
	D.LEVEL	0-100
	FX1:HUMAN (FX1:HUMANIZER) FX2:HUMAN (FX2:HUMANIZER) FX3:HUMAN (FX3:HUMANIZER)	MODE
VOWEL1		a, e, i, o, u
VOWEL2		a, e, i, o, u
SENS		0-100
RATE		0-100, BPM $\frac{1}{2}$ - $\frac{1}{4}$
DEPTH		0-100
MANUAL		0-100
LEVEL	0-100	
FX1:MST.FX (FX1:MASTERING FX) FX2:MST.FX (FX2:MASTERING FX) FX3:MST.FX (FX3:MASTERING FX)	TYPE	NAT.COMP (NATURAL COMP), MIXERCMP (MIXER COMP), LIVECOMP, NAT.LIM (NATURAL LIMITER), HARD LIM (HARD LIMITER), SOLO, METAL, ACOUSTIC, ROCK, LOWBOOST, BRIGHTEN
	DYNAMICS	-20+20
	TONE	-6+6
	NATURAL	-50+50
FX1:OCTAVE FX2:OCTAVE FX3:OCTAVE	TYPE	MONO, POLY
	-2OCT	0-100
	-1OCT	0-100
	D.LEVEL	0-100
	RANGE	0-100
FX1:OCT BS (FX1:OCTAVE BASS) FX2:OCT BS (FX2:OCTAVE BASS) FX3:OCT BS (FX3:OCTAVE BASS)	POLY OCT (POLY OCTAVE LEVEL)	0-100
	2-Oct	0-100
	1-Oct	0-100
FX1:OVERTON (FX1:OVERTONE) FX2:OVERTON (FX2:OVERTONE) FX3:OVERTON (FX3:OVERTONE)	D.LEVEL	0-100
	LOWER LEVEL	0-100
	UPPER LEVEL	0-100
	UNISON LEVEL	0-100
	D.LEVEL	0-100
	DETUNE	0-100
	LO	-50+50
HI	-50+50	
OUTPUT	MONO, STEREO	

CATEGORY	TARGET	Value
FX1:PAN FX2:PAN FX3:PAN	RATE	0-100, BPM $\frac{1}{2}$ - $\frac{1}{4}$
	DEPTH	0-100
	WAVEFORM	0-100
	E.LEVEL	0-100
FX1:PHASER FX2:PHASER FX3:PHASER	DIR MIX	0-100
	TYPE	PRIME, SCRIPT
	STAGE	2 STAGE, 4 STAGE, 8 STAGE, 16 STAGE, 24 STAGE
	RATE	0-100, BPM $\frac{1}{2}$ - $\frac{1}{4}$
	DEPTH	0-100
	RESO (RESONANCE)	0-100
	MANUAL	0-100
	LO DAMP	0-100
	HI DAMP	0-100
	LO CUT	FLAT, 20.0Hz-20.0kHz
	HI CUT	20.0Hz-20.0kHz, FLAT
	BI-PHASE	OFF, ON
	WAVE (WAVEFORM)	TRI, SINE
FX1:P-SHIF (FX1:PITCH SHIFTER) FX2:P-SHIF (FX2:PITCH SHIFTER) FX3:P-SHIF (FX3:PITCH SHIFTER)	STEP (STEP RATE)	OFF, 0-100, BPM $\frac{1}{2}$ - $\frac{1}{4}$
	SEPARAT (SEPARATION)	0-180
	E.LEVEL	0-100
	DIR MIX	0-100
	VOICE	1VOICE, 2MONO, 2STEREO
	1:PITCH 2:PITCH	-24+24
	1:FINE (1:PITCH FINE) 2:FINE (2:PITCH FINE)	-50+50
	1:FBK (1:FEEDBACK)	0-100
	1:PrDLY (1:PRE-DELAY) 2:PrDLY (2:PRE-DELAY)	0ms-300ms, BPM $\frac{1}{2}$ - $\frac{1}{4}$
	1:LEVEL 2:LEVEL	0-100
FX1:RNG MOD (FX1:RING MODULATOR) FX2:RNG MOD (FX2:RING MODULATOR) FX3:RNG MOD (FX3:RING MODULATOR)	1:MODE 2:MODE	FAST, MEDIUM, SLOW, MONO
	D.LEVEL	0-100
	INTELLI (INTELLIGENT)	OFF, ON
	FREQ (FREQUENCY)	0-100
	ModRATE (FREQUENCY MOD RATE)	0-100, BPM $\frac{1}{2}$ - $\frac{1}{4}$
	ModDEPT (FREQUENCY MOD DEPTH)	0-100
	E.LEVEL	0-100
DIR MIX	0-100	

CATEGORY	TARGET	Value
FX1:ROTARY FX2:ROTARY FX3:ROTARY	SPEED	SLOW, FAST
	SLOW RT (SLOW RATE)	0-100, BPM
	FAST RT (FAST RATE)	0-100, BPM
	RISE TM (RISE TIME)	0-100
	FALL TM (FALL TIME)	0-100
	MIC DIST (MIC DISTANCE)	0-100
	ROT/HRN (ROTOR/HORN BALANCE)	100:0-0:100
	DRIVE	0-100
	E.LEVEL	0-100
	DIR MIX	0-100
FX1:SITAR (FX1:SITAR SIMULATOR) FX2:SITAR (FX1:SITAR SIMULATOR) FX3:SITAR (FX1:SITAR SIMULATOR)	SENS	0-100
	DEPTH	0-100
	tone	-50+50
	E.LEVEL	0-100
	RESONANCE	0-100
FX1:SLICER FX2:SLICER FX3:SLICER	BUZZ	0-100
	DIR MIX	0-100
	PATTERN	P1-P20
	RATE	0-100, BPM
	ATTACK	0-100
	DUTY	1-99
FX1:SG (FX1:SLOW GEAR) FX2:SG (FX2:SLOW GEAR) FX3:SG (FX3:SLOW GEAR)	TRIGGER	OFF, ON
	E.LEVEL	0-100
	DIR MIX	0-100
FX1:SG BASS (FX1:SLOW GEAR BASS) FX2:SG BASS (FX2:SLOW GEAR BASS) FX3:SG BASS (FX3:SLOW GEAR BASS)	SENS	0-100
	RISE TIME	0-100
	LEVEL	0-100
FX1:S-HOLD (FX1:SOUND HOLD) FX2:S-HOLD (FX2:SOUND HOLD) FX3:S-HOLD (FX3:SOUND HOLD)	TRIGGER	OFF, ON
	RISE TIME	0-100
	E.LEVEL	0-100
FX1:S-BEND FX2:S-BEND FX3:S-BEND	TRIGGER	OFF, ON
	PITCH	-3oct, -2oct, -1oct, +1oct, +2oct, +3oct, +4oct
	RISE TM (RISE TIME)	0-100
	FALL TM (FALL TIME)	0-100
FX1:TW (FX1:TOUCH WAH) FX1:TW (FX1:TOUCH WAH) FX1:TW (FX1:TOUCH WAH)	FILTER MODE	LPF, BPF, HPF
	POLARITY	DOWN, UP
	SENS	0-100
	FREQUENCY	0-100
	RESONANCE	0-100
	DECAY	0-100
	E.LEVEL	0-100
	DIR MIX	0-100

CATEGORY	TARGET	Value
FX1:TW BS (FX1:TOUCH WAH BASS) FX2:TW BS (FX2:TOUCH WAH BASS) FX3:TW BS (FX3:TOUCH WAH BASS)	FILTER MODE	LPF, BPF, HPF
	POLARITY	DOWN, UP
	SENS	0-100
	FREQUENCY	0-100
	RESONANCE	0-100
	DECAY	0-100
	E.LEVEL	0-100
	DIR MIX	0-100
FX1:TREMOLO FX2:TREMOLO FX3:TREMOLO	RATE	0-100, BPM
	DEPTH	0-100
	WAVEFORM	0-100
	TRIGGER	0-100
	RISE TIME	0-100
	E.LEVEL	0-100
	DIR MIX	0-100
FX1:VIB (FX1:VIBRATO) FX2:VIB (FX2:VIBRATO) FX3:VIB (FX3:VIBRATO)	RATE	0-100, BPM
	DEPTH	0-100
	COLOR	0-100
	TRIGGER	OFF, ON
	RISE TIME	0-100
	E.LEVEL	0-100
REVERB	DIR MIX	0-100
	ON/OFF	OFF, ON
	TYPE	HALL1, HALL2, PLATE, ROOM1, ROOM2, AMBIENCE, SPRING, SHIMMER, DUAL, TERA ECO (TERA ECHO)
	TIME	0.1s-10.0s
	DENSITY	1-10
	PRE DELAY	0ms-200ms
	tone	-50+50
	E.LEVEL	0-100
	D.LEVEL	0-100
	LO CUT	FLAT, 20.0Hz-20.0kHz
	HI CUT	20.0Hz-20.0kHz, FLAT
	LO DAMP	-50+50
	HI DAMP	-50+50
	MOD RATE	0-100
	MOD DEPTH	0-100
	DUCK SENS	0-100
	DUCK PRE DPT (DUCKING PRE DEPTH)	0-100
DUCK PST DPT (DUCKING POST DEPTH)	0-100	
REVERB: SHIMMER	1:PITCH	-24+24
	2:PITCH	
	1:LEVEL	0-100
	2:LEVEL	

CATEGORY	TARGET	Value	
REVERB: DUAL	1:TYPE 2:TYPE	HALL, PLATE, ROOM	
	1:TIME 2:TIME	0.1–10.0s	
	1:PRE-DLY (1:PRE-DELAY) 2:PRE-DLY (2:PRE-DELAY)	0ms–200ms	
	1:DENSITY 2:DENSITY	1–10	
	1:TONE 2:TONE	-50+50	
	1:E.LEVEL (1:EFFECT LEVEL) 2:E.LEVEL (2:EFFECT LEVEL)	0–100	
	1:LO CUT (1:LOW CUT) 2:LO CUT (2:LOW CUT)	FLAT, 20.0Hz–20.0kHz	
	1:HI CUT (1:HIGH CUT) 2:HI CUT (2:HIGH CUT)	20.0Hz–20.0kHz, FLAT	
	REVERB: TERA ECHO	MODE	MONO, STEREO1, STEREO2
		STIME (S-TIME)	0–100
FBK (FEEDBACK)		0–100	
TRIG (TRIGGER)		OFF, ON	
PEDAL FX	ON/OFF	OFF, ON	
	TYPE	PDL BEND (PEDAL BEND), WAH	
	E.LEVEL	0–100	
	DIR MIX	0–100	
PEDAL BEND	PITCH MIN	PITCH MIN	
	PITCH MAX	PITCH MAX	
	PEDAL POS (PEDAL POSITION)	0–100	
PEDAL WAH	TYPE	CRY WAH, VO WAH, FAT WAH, LIGHT WAH, 7STR WAH (7STRING WAH), RESO WAH, BASS WAH	
	PEDAL POS (PEDAL POSITION)	0–100	
	PEDAL MIN	0–100	
	PEDAL MAX	0–100	
FOOT VOLUME	PEDAL POS (PEDAL POSITION)	0–100	
	VOLUME MIN	0–100	
	VOLUME MAX	0–100	
	VOLUME CURVE	SLOW1, SLOW2, NORMAL, FAST	
DIV1 (DIVIDER 1) DIV2 (DIVIDER 2) DIV3 (DIVIDER 3)	MODE	SINGLE, DUAL	
	CH SELECT	A, B	
	Ch.A DYNAMIC Ch.B DYNAMIC	OFF, POLAR+ (POLARITY +), POLAR- (POLARITY -)	
	Ch.A DYNA SENS (Ch.A DYNAMIC SENS) Ch.B DYNA SENS (Ch.B DYNAMIC SENS)	0–100	
	Ch.A FILTER Ch.B FILTER	OFF, LPF, HPF	
	Ch.A CUTOFF (Ch.A CUTOFF REUQUENCY) Ch.B CUTOFF (Ch.B CUTOFF REUQUENCY)	100Hz–4.00kHz	

CATEGORY	TARGET	Value
MIX 1 (MIXER 1) MIX 2 (MIXER 2) MIX 3 (MIXER 3)	MODE	STEREO, PAN L/R
	Ch.A LEVEL Ch.B LEVEL	0–100
	Ch.A/B BALANCE	100:0–0:100
	SPREAD	0–100
S/R 1 (SEND/RETURN 1) S/R 2 (SEND/RETURN 2)	ON/OFF	OFF, ON
	MODE	NORMAL, DIR MIX (DIRECT MIX), BRANCH (BRANCH OUT)
	SEND LEVEL	0–200
	RETURN LEVEL	0–200
	ADJUST	0–100
LOOPER	PLAY LEVEL	0–100
AMP CTL (AMP CONTROL)	CTL 1 *1	OFF, ON
	CTL 2 *1	OFF, ON
MASTER	PATCH LEVEL	0–200
	BPM	40–250
	KEY	C (Am)–B (G#m)
	BASS MODE	OFF, ON
MIDI	MIDI CC#	–
	MIDI PC#	–
TUNER	ON/OFF	OFF, ON

*1 This is enabled when CTL 4, 5 SETTING is set to AMP CTL.

Virtual Expression Pedal (Internal Pedal / Wave Pedal)

By assigning a desired parameter to the virtual expression pedal, you can produce an effect as though you were operating a physical expression pedal to change the volume or tone quality in real time.

The virtual expression pedal system provides the following two types of functions, and you can use the SOURCE setting for ASSIGN 1–16 to choose the desired type.

Internal pedal

If SOURCE is set to "INT PEDAL," the virtual expression pedal will begin operating when started by the specified trigger (TRIGGER), modifying the parameter specified by "TARGET."

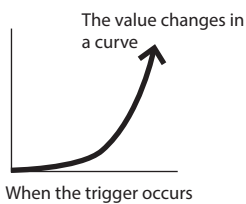

Wave pedal

If SOURCE is set to "WAVE PEDAL," the virtual expression pedal will cyclically modify the parameter specified by TARGET in a fixed wave form.

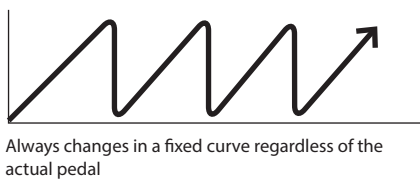

INPUT (Input Level)

The parameter set as the target changes in response to the input level.

MEMO

If you want to adjust the input sensitivity, set the INPUT SENS.

INPUT SENS (Input Sens)

Parameter	Value	Explanation
INPUT SENS	0–100	This adjusts the input sensitivity when INPUT LEVEL is selected for SOURCE.

About the Range of a Target's Change

The value of the parameter selected as the target changes within the range defined by "Min" and "Max," as set on the GT-1000CORE.

When using an external footswitch, or other controller that acts as an on/off switch, "Min" is selected with Off (CLOSED), and "Max" is selected with On (OPEN).

When using an external expression pedal or other controller that generates a consecutive change in the value, the value of the setting changes accordingly, within the range set by the minimum and maximum values. Also, when the target is of an on/off type, the median value of the received data is used as the dividing line in determining whether to switch it on or off.

When using the footswitch:

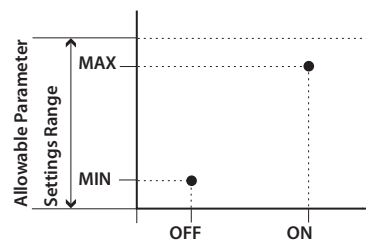

When using the expression pedal:

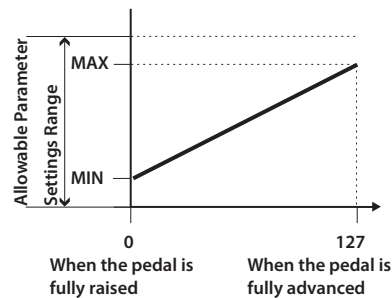

When controlling the On/Off target with the expression pedal:

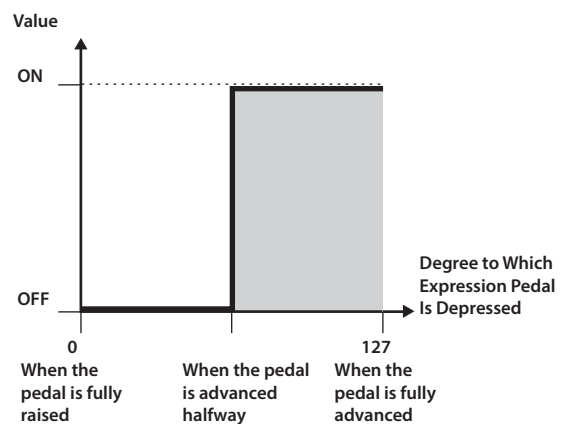

- * The range that can be selected changes according to the target setting.
- * When the "minimum" is set to a higher value than the "maximum," the change in the parameter is reversed.
- * The values of settings can change if the target is changed after the "minimum" and "maximum" settings have been made. If you've changed the target, be sure to recheck the "minimum" and "maximum" settings.

About the Range of a Controller's Change

This sets the operational range within which the value of the setting changes when an expression pedal or other controller that changes the value consecutively is used as the source. If the controller is moved outside the operational range, the value does not change, it stops at "minimum" or "maximum."

(Example) With ACT LOW: 40, ACT HIGH: 80

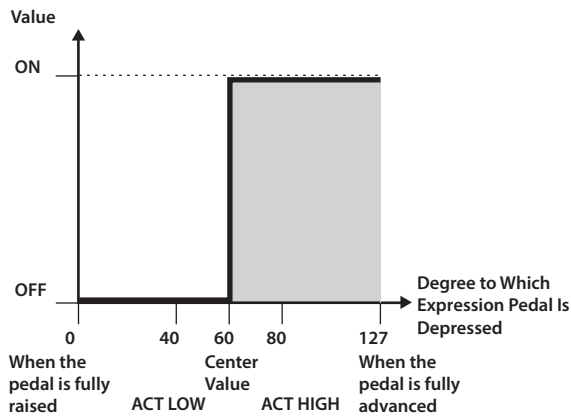
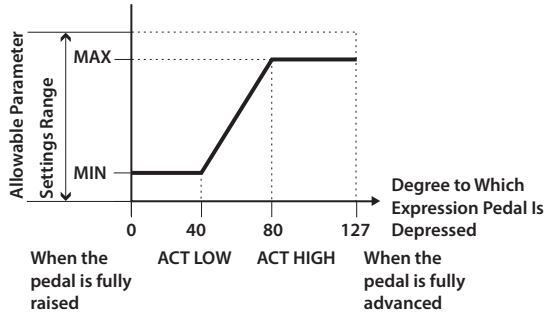

* When using a footswitch or other on/off switching controller as the source, leave these at "ACT LOW: 0" and "ACT HIGH: 127." With certain settings, the value may not change.

Parameter	Value	Explanation
CC1# CC2#	OFF, 0-127	Specifies whether a control change is transmitted when you switch patches. If this is OFF, no control change is transmitted.
CC1 VAL (CC1 VALUE) CC2 VAL (CC2 VALUE)	0-127	Specifies the value of the control change.

LED COLOR

You can specify the color of the LED for each footswitch.

[▼] switch, [▲]switch, [CTL1] switch

Value	Explanation
OFF	The LED is not lit.
RED BLUE L.BLUE (LIGHT BLUE) GREEN YELLOW WHITE PURPLE	Specify the color of LED illumination.
AUTO	The illumination behavior and color that are appropriate for the footswitch function will be specified. If "ON" is set to AUTO, the OFF setting is ignored.
AUTO RED AUTO BLUE AUTO L.BLUE (LIGHT BLUE) AUTO GREEN AUTO YELLOW AUTO WHITE AUTO PURPLE	The illumination behavior that is appropriate for the footswitch function will be specified. You can specify the color. If "ON" is set to AUTO, the OFF setting is ignored.

PATCH MIDI

When you change patches, a program number and bank select messages are transmitted to an external MIDI device.

PATCH MIDI 1, 2, 3, 4

Parameter	Value	Explanation
CH	OFF, 1-16	Specifies the transmit channel for MIDI messages. If this is OFF, no MIDI message is transmitted.
PC#	OFF, 1-128	Specifies whether a program number is transmitted when you switch patches. If this is OFF, no program number is transmitted.
BANK MSB BANK LSB	OFF, 0-127	Specifies whether bank select messages are transmitted when you switch patches. * It is not possible to transmit only BANK LSB. * Not transmitted if PC# is OFF. * It is not possible to transmit only bank select. Bank select is always transmitted in conjunction with program numbers.

TEMPO HOLD

Parameter	Value	Explanation
TEMPO HOLD	OFF, ON	Specifies whether the tempo (BPM) changes or is maintained when you switch patches.

IN/OUT SETTING

INPUT

Adjust the input level according to the output level of the guitar that you've connected.

Parameter	Value	Explanation
INPUT LEVEL	-20~+20dB	Adjusts the guitar input level.

OUTPUT, SUB OUT

Specify the device (amp) that's connected to the OUTPUT, SEND jacks.

OUTPUT SELECT

Parameter	Value	Explanation
AIRD OUTPUT SELECT		
Value	Explanation	
LINE/PHONES	Choose this setting if you're using headphones, or if the GT-1000CORE is connected to a keyboard amp, mixer, or digital recorder. The speaker type for the preamp is fixed (original).	
RECORDING	Choose this setting if you're using headphones, or if the GT-1000CORE is connected to a keyboard amp, mixer, or digital recorder. This setting lets you freely select the speaker type.	
JC-120 RETURN	Choose this setting if the GT-1000CORE is connected to the RETURN jack of the Roland JC-120 guitar amp.	
JC-120 INPUT	Choose this setting if the GT-1000CORE is connected to the guitar input of a JC-120 guitar amp.	
Blues Cube Tour410 RETURN	Choose this setting if the GT-1000CORE is connected to the RETURN jack of the Roland Blues Cube Tour guitar amp. This assumes that the connected speaker cabinet is the Blues Cube Cabinet 410.	
Blues Cube Tour410 INPUT	Choose this setting if the GT-1000CORE is connected to the guitar input of a Roland Blues Cube Tour guitar amp. This assumes that the connected speaker cabinet is the Blues Cube Cabinet 410.	
Blues Cube Artist212 RETURN	Choose this setting if the GT-1000CORE is connected to the RETURN jack of the Roland Blues Cube Artist212 guitar amp.	
Blues Cube Artist212 INPUT	Choose this setting if the GT-1000CORE is connected to the guitar input of a Roland Blues Cube Artist212 guitar amp.	
WAZA Amp 412 RETURN	Choose this setting if the GT-1000CORE is connected to the RETURN jack of the BOSS WAZA Amp Head guitar amp. This assumes that the connected speaker cabinet is the WAZA Amp Cabinet 412.	
WAZA Amp 412 INPUT	Choose this setting if the GT-1000CORE is connected to the guitar input of a BOSS WAZA Amp Head guitar amp. This assumes that the connected speaker cabinet is the WAZA Amp Cabinet 412.	
WAZA Amp 212 RETURN	Choose this setting if the GT-1000CORE is connected to the RETURN jack of the BOSS WAZA Amp Head guitar amp. This assumes that the connected speaker cabinet is the WAZA Amp Cabinet 212.	
WAZA Amp 212 INPUT	Choose this setting if the GT-1000CORE is connected to the guitar input of a BOSS WAZA Amp Head guitar amp. This assumes that the connected speaker cabinet is the WAZA Amp Cabinet 412.	
KATANA-100/212 GEN 3 POWER AMP IN	Choose this setting if the GT-1000CORE is connected to the POWER AMP IN of a BOSS KATANA-100/212 GEN 3 guitar amp.	
KATANA-100 GEN 3 POWER AMP IN	Choose this setting if the GT-1000CORE is connected to the POWER AMP IN of a BOSS KATANA-100 GEN 3 guitar amp.	

Value	Explanation
KATANA-50 GEN 3 POWER AMP IN	Choose this setting if the GT-1000CORE is connected to the POWER AMP IN of a BOSS KATANA-50 GEN 3 guitar amp.
KATANA-100/212 MkII POWER AMP IN	Choose this setting if the GT-1000CORE is connected to the POWER AMP IN of a BOSS KATANA-100/212 MkII guitar amp.
KATANA-100 MkII POWER AMP IN	Choose this setting if the GT-1000CORE is connected to the POWER AMP IN of a BOSS KATANA-100 MkII guitar amp.
KATANA-50 MkII POWER AMP IN	Choose this setting if the GT-1000CORE is connected to the POWER AMP IN of a BOSS KATANA-50 MkII guitar amp.
KATANA-100/212 RETURN	Choose this setting if the GT-1000CORE is connected to the RETURN jack of the KATANA-100/212 guitar amp.
KATANA-100/212 INPUT	Choose this setting if the GT-1000CORE is connected to the guitar input of a KATANA-100/212 guitar amp.
KATANA-100 RETURN	Choose this setting if the GT-1000CORE is connected to the RETURN jack of the KATANA-100 guitar amp.
KATANA-100 INPUT	Choose this setting if the GT-1000CORE is connected to the guitar input of a KATANA-100 guitar amp.
KATANA-50 INPUT	Choose this setting if the GT-1000CORE is connected to the guitar input of a KATANA-50 guitar amp.
TUBE COMBO 212 RETURN	This setting is for cases other than the above when connecting to the RETURN of a vacuum tube combo amp (in which the amp and speakers are in a single unit) equipped with two 12" speakers.
TUBE COMBO 212 INPUT	This setting is for cases other than the above when connecting to the INPUT of a vacuum tube combo amp (in which the amp and speakers are in a single unit) equipped with two 12" speakers.
TUBE COMBO 112 RETURN	This setting is for cases other than the above when connecting to the RETURN of a vacuum tube combo amp (in which the amp and speakers are in a single unit) equipped with one 12" speaker.
TUBE COMBO 112 INPUT	This setting is for cases other than the above when connecting to the INPUT of a vacuum tube combo amp (in which the amp and speakers are in a single unit) equipped with one 12" speaker.
TUBE STACK 412 RETURN	This setting is for cases other than the above when connecting to the RETURN of a vacuum tube stack guitar amp (in which the amp and speakers are separate units). This assumes that the connected speaker cabinet is equipped with four 12" speakers.
TUBE STACK 412 INPUT	This setting is for cases other than the above when connecting to the INPUT of a vacuum tube stack guitar amp (in which the amp and speaker are separate units). This assumes that the connected speaker cabinet is equipped with four 12" speakers.
NEXTONE-Artist RETURN	Choose this setting if the GT-1000CORE is connected to the RETURN jack of the NEXTONE-Artist guitar amp. This assumes that the POWER AMP SELECT is set to EL34.
NEXTONE-Stage RETURN	Choose this setting if the GT-1000CORE is connected to the RETURN jack of the NEXTONE-Stage guitar amp. This assumes that the POWER AMP SELECT is set to EL34.
MUSTANG 212 RETURN	A setting for the connection to the RETURN jack of the Fender MUSTANG guitar amp. This assumes that the connected speaker cabinet is equipped with two 12" speakers.
Hot Rod Deluxe RETURN	A setting for the connection to the RETURN jack of the Fender Hot Rod Deluxe guitar amp.
Twin Reverb INPUT	A setting for the connection to the guitar input of the Fender Twin Reverb guitar amp.
AC30 INPUT	A setting for the connection to the guitar input of the VOX AC30 guitar amp.
JCM2000 412 RETURN	A setting for the connection to the RETURN jack of the Marshall JCM2000 guitar amp. The connected cabinet is assumed to be a Marshall cabinet with four 12" speakers.
JVM410H 412 RETURN	A setting for the connection to the RETURN jack of the Marshall JVM410H guitar amp. The connected cabinet is assumed to be a Marshall cabinet with four 12" speakers.
Rectifier 412 RETURN	A setting for the connection to the RETURN jack of the MESA/Boogie Rectifier guitar amp. The connected cabinet is assumed to be a MESA/Boogie cabinet with four 12" speakers.

Value	Explanation
TriAmp 412 RETURN	A setting for the connection to the RETURN jack of the Hughes & Kettner TriAmp guitar amp. The connected cabinet is assumed to be a Hughes & Kettner cabinet with four 12" speakers.
BASS AMP WITH TWEETER	Use this setting when connecting to a bass amp that has no tweeter.
BASS AMP NO TWEETER	Use this setting when connecting to a tweeter-equipped bass amp.
USER1, USER2	You can use a dedicated tool to download settings from the BOSS website and add them to USER1 and USER2. Download the dedicated tool from the BOSS website. http://www.boss.info/support/

* Company names and product names appearing in this document are registered trademarks or trademarks of their respective owners.

* In this manual, company names and product names of the respective owners are used because it is the most practical way of describing the sounds that are emulated using DSP technology.

GLOBAL EQ

This adjusts the tone of the OUTPUT regardless of the equalizer on/off settings of individual patches.

* If the STEREO LINK is ON, the L settings are also applied to R.

Parameter	Value	Explanation
ST LINK (STEREO LINK)	OFF, ON	If this is ON, the L and R settings are made at the same time.
LO GAIN (LOW GAIN) L:LO GAIN (L:LOW GAIN) R:LO GAIN (R:LOW GAIN)	-20+20dB	Adjusts the tone for the low frequency range.
MID GAIN L:MID GAIN R:MID GAIN	-20+20dB	Adjusts the tone for the middle frequency range.
MID FREQ L:MID FREQ R:MID FREQ	20.0Hz-16.0kHz	Specifies the center of the frequency range that will be adjusted by the MID GAIN.
MID Q L:MID Q R:MID Q	0.5-16	Adjusts the width of the area affected by the EQ centered at the MID FREQ. Higher values will narrow the area.
HI GAIN (HIGH GAIN) L:HI GAIN (L:HIG GAIN) R:HI GAIN (R:HIG GAIN)	-20+20dB	Adjusts the tone for the high frequency range.
LO CUT (LOW CUT) L:LO CUT (L:LOW CUT) R:LO CUT (R:LOW CUT)	FLAT, 20.0Hz-20.0kHz	This sets the frequency at which the low cut filter begins to take effect. When FLAT is selected, the low cut filter will have no effect.
HI CUT (HIGH CUT) L:HI CUT (L:HIG CUT) R:HI CUT (R:HIG CUT)	20.0Hz-20.0kHz FLAT	This sets the frequency at which the high cut filter begins to take effect. When FLAT is selected, the high cut filter will have no effect.

* GLOBAL EQ of SUB OUT is enabled only when SEND1 SETTING and SEND2 SETTING are set to SUB OUT.

OUTPUT LEVEL (SUB OUT)

Parameter	Value	Explanation
OUTPUT LEVEL	0-100	Adjusts the output level (SUB OUT only).

* This is only enabled when SEND1 SETTING and SEND2 SETTING are set to SUB OUT.

TOTAL

These parameters control the threshold level of the noise suppressor used by each patch, the overall reverb level, and the overall output. They do not affect the settings of each patch.

Parameter	Value	Explanation
NS THRESHLD (NS THRESHOLD)	-20dB-0dB- +20dB	Control the threshold level of the noise suppressor used by each patch. It is effective to adjust this when you switch to connecting a different guitar, or according to the amount of noise in the performance venue. This does not affect the settings of each patch. * If you want to use the settings specified for each patch, set this to 0 dB.
REVERB LEVEL	0%-200%	Adjusts the reverb level specified for each patch. It is useful to adjust the reverb level appropriately for the space in which you're performing. This does not affect the settings of each patch. * If you want to use the settings specified for each patch, set this to 100%.

USB-Related Settings

Here you can make USB-related settings for when the GT-1000CORE is connected to a computer via USB.

USB audio flow

GT-1000CORE provides three USB audio outputs: "OUTPUT", "SUB OUT" and "DRY."

OUTPUT outputs the effect sound from OUTPUT; the return from the computer is mixed with the guitar's performance at the final stage of OUTPUT.

SUB OUT outputs the effect sound from SUB OUT; the return from the computer is mixed with the guitar's performance at the final stage of SUB OUT.

DRY always outputs the dry sound regardless of the GT-1000CORE unit's settings; the return from the computer is always returned to the beginning of the effect chain.

Since the GT-1000CORE is outputting to the computer from each of OUTPUT, SUB OUT, and DRY, you can provide three tracks for guitar and simultaneously record the dry sound, the effect sound from OUTPUT, and the effect sound from SUB OUT.

If you are not satisfied with the effect sound from MAIN OUT or SUB OUT, you can play back the dry sound that was simultaneously recorded from DRY, and pass it through the effect chain of the GT-1000CORE to remake the sound.

* SUB OUT is enabled only when SEND1 SETTING and SEND2 SETTING are set to SUB OUT.

OUTPUT

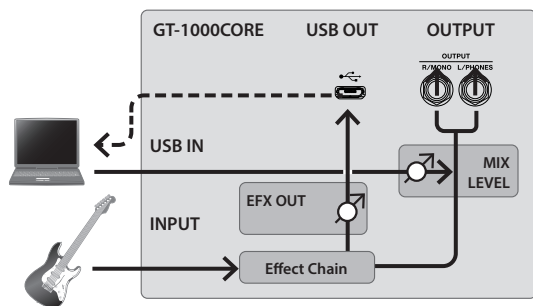

SUB OUT

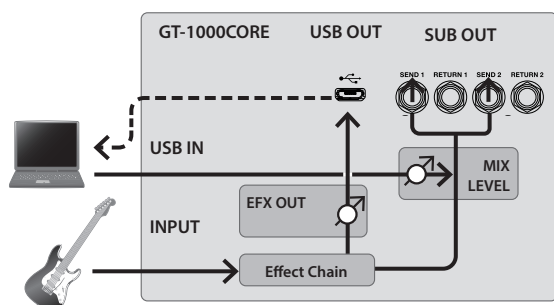

DRY

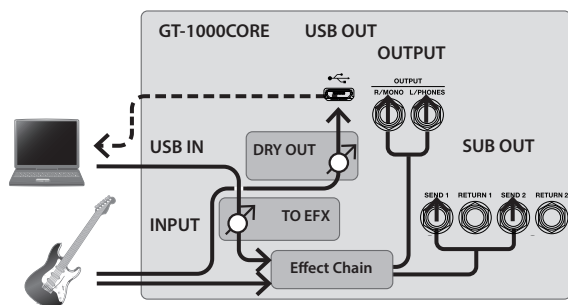

OUTPUT

Parameter	Value	Explanation
MIX LEVEL	0-200%	Adjusts the level of the input sound from the computer. At this time, the input sound from the computer is mixed at the final stage of the GT-1000CORE's OUTPUT.
EFX OUT	0-200%	Adjusts the level of the sound that is output to the computer from OUTPUT after passing through the GT-1000CORE's effects.
DIR MON	Selects whether the sound of the GT-1000CORE, is output to the OUTPUT jacks. * This setting cannot be saved. It will be ON when the unit is powered-on.	
	OFF	Turn this off if the audio data is being passed through within the computer. In this case, you won't hear the sound unless the computer is set to through.
	ON	The sound of the GT-1000CORE, is output directly. Turn this on if you're using the GT-1000CORE, by itself without connecting to a computer. (If this is off, only the sound that is input to USB will be output.)

SUB OUT

Parameter	Value	Explanation
MIX LEVEL	0-200%	Adjusts the level of the sound that is input from the computer. In this case, the input sound from the computer is mixed at the final stage of the GT-1000CORE's SUB OUT.
EFX OUT	0-200%	Adjusts the level of the sound that is output to the computer from SUB OUT after passing through the GT-1000CORE's effects.
DIR MON	Selects whether the sound of the GT-1000CORE, is output to the PHONES jack or the SUB OUTPUT jacks. * This setting cannot be saved. It will be ON when the unit is powered-on.	
	OFF	Turn this off if the audio data is being passed through within the computer. In this case, you won't hear the sound unless the computer is set to through.
	ON	The sound of the GT-1000CORE, is output directly. Turn this on if you're using the GT-1000CORE, by itself without connecting to a computer. (If this is off, only the sound that is input to USB will be output.)

* SUB OUT is enabled only when SEND1 SETTING and SEND2 SETTING are set to SUB OUT.

DRY

Parameter	Value	Explanation
OUT	0-200%	The guitar sound that is input to the GT-1000CORE, is output without change (DRY sound); it is not processed by effects.
TO EFX	0-200%	Adjusts the input level from the computer to the GT-1000CORE's effects.

PLAY OPTION

Here you can specify how the pedals will work during performance.

Parameter	Value	Explanation
PATCH EXTENT MIN	U001–P250,	Sets the lower limit for the banks.
PATCH EXTENT MAX	U001–P250,	Sets the upper limit for the banks.
PHRASE LOOP MODE	MONO	Mixes the L/R signals for mono operation. The recording time is 38 seconds.
	STEREO	Operate in stereo. The recording time is 19 seconds.
PHRASE LOOP REC ACTION	Specifies how the looper operates when you press the pedal.	
	REC → PLAY → DUB	Operation switches in the order of record → play → overdub.
	REC → DUB → PLAY	Operation switches in the order of record → overdub → play.

MIDI

Here you can make settings for using the GT-1000CORE connected with an external MIDI device or with a second GT-1000CORE unit.

Reference

For more about MIDI, refer to “Connecting External MIDI Devices” in the owner’s manual.

MIDI SETTING

Parameter	Value	Explanation
RX CH (RX CHANNEL)	This sets the MIDI channel used for receiving MIDI messages.	
	Ch. 1– Ch. 16	Specifies the receive channel.
OMNI MODE	This makes the settings for the channels used for MIDI information.	
	OFF	Information is received on the channel specified by the RX CHANNEL setting.
	ON	Messages are received on all channels, regardless of the MIDI channel settings.
TX CH (TX CHANNEL)	Sets the MIDI channel used for transmitting MIDI messages.	
	Ch. 1– Ch. 16. RX	Specifies the transmit channel. Transmits on the same channel as the RX CHANNEL.
DEVICE ID	This sets the MIDI Device ID used for transmitting and receiving Exclusive messages.	
	1–32	Sets the MIDI Device ID.
MIDI THRU (MIDI IN THRU)	This specifies the connector from which to output the MIDI messages that are received at the MIDI IN connector.	
	OFF	MIDI messages are not transmitted.
	MIDI OUT	Messages are transmitted from the MIDI OUT connector.
	USB OUT	Messages are transmitted from the USB port.
USB THRU (USB IN THRU)	This specifies the connector from which to output the MIDI messages that are received at the USB port.	
	OFF	MIDI messages are not transmitted.
	MIDI OUT	Messages are transmitted from the MIDI OUT connector.
	USB OUT	Messages are transmitted from the USB port.
SYNC CLK (SYNC CLOCK)	This setting determines the basis used for synchronizing the timing for effect modulation rates and other time-based parameters.	
	* When you have an external MIDI device connected, the MASTER BPM is then synchronized to the external MIDI device’s tempo, thus disabling the MASTER BPM setting. To enable setting of the MASTER BPM, set to “INTERNAL.”	
	* When synchronizing performances to the MIDI Clock signal from an external MIDI device, timing problems in the performance may occur due to errors in the MIDI Clock.	
	AUTO	Operations are synchronized to MIDI clock messages received via MIDI or USB. However, operations are automatically synchronized to the GT-1000CORE’s internal clock if the GT-1000CORE, is unable to receive the external Clock.
	INTERNAL	Operations are synchronized to the GT-1000CORE’s internal Clock.
MIDI (AUTO)	Operations are synchronized to the MIDI Clock received via MIDI. However, operations are automatically synchronized to the GT-1000CORE’s internal Clock if the GT-1000CORE is unable to receive the external Clock.	
USB (AUTO)	Operations are synchronized to the USB Clock received via USB. However, operations are automatically synchronized to the GT-1000CORE’s internal Clock if the GT-1000CORE is unable to receive the external Clock.	

Parameter	Value	Explanation
CLK OUT (CLOCK OUT)	Specifies whether MIDI clock will be output from the GT-1000CORE.	
	OFF	MIDI clock is not output.
	ON	MIDI clock is output.
MAP SEL (MAP SELECT)	Specifies whether program change messages received by the GT-1000CORE, will switch patches according to the settings of the program change map or will switch patches according to the default settings.	
	FIX	This deactivates the Program Change Map. Switches to the patches according to the default settings.
	PROG	This activates the Program Change Map. Switches to the patches according to the Program Change Map.
▼ CC# ▲ CC#	Specifies the controller number when transmitting pedal operations as control change messages.	
CTL1 CC#	OFF	Control Change messages are not output.
CTL2 CC#	CC#1–CC#31, CC#64–CC#95	Pedal operations are transmitted using the specified controller number.
CTL3 CC#		
CTL4 CC#		
CTL5 CC#		
EXP1 CC#		
EXP2 CC#		

PROGRAM MAP BANK1–BANK4

When switching patches using Program Change messages transmitted by an external MIDI device, you can freely set the correspondence between Program Change messages received by the GT-1000CORE and the patches to be switched to in the “Program Change Map.”

Parameter	Value	Explanation
PC#1–PC#128	U001–U250, P001–P250	This sets the patch number (U001–U250, P001–P250) for the corresponding Program Change number.

BULK DUMP

You can use Exclusive messages to provide another GT-1000CORE with identical settings, and save effect settings on a MIDI sequencer or other device.

Parameter	Value	Explanation
FROM TO	SYSTEM	System parameter settings
	U001–U250	Settings for Patch Number U001 through U250
	STOMPBOX	Stomp box settings
	TEMP	Settings for the patch that is currently selected

HARDWARE SETTING

KNOB

Here you can assign the desired parameters to knobs [1]–[6] in the Play Screen.

* The settings you make here are only for the knobs in the Play Screen.

Parameter	
KNOB 1–KNOB 5	
Value (Category)	Value (Target)
COMP (COMPRESSOR)	ON/OFF
	TYPE
	SUSTAIN
	ATTACK
	RATIO
	TONE
	LEVEL
	DIR MIX
	CMP:BASS (COMPRESSOR:BASS)
DIST 1 (DISTORTION 1) DIST 2 (DISTORTION 2)	ON/OFF
	TYPE
	DRIVE
	TONE
	LEVEL
	BOTTOM
	DIR MIX
	SOLO SW
	SOLO LEVEL
PREAMP 1 (AIRD PREAMP 1) PREAMP 2 (AIRD PREAMP 2)	ON/OFF
	TYPE
	GAIN
	SAG
	RESO (RESONANCE)
	BASS
	MIDDLE
	TREBLE
	PRESENCE
	BRIGHT
	LEVEL
	GAIN SW
	SOLO SW
	SOLO LVL (SOLO LEVEL)
NS 1 (NOISE SUPPRESSOR 1) NS 2 (NOISE SUPPRESSOR 2)	ON/OFF
	THRESHOLD
	RELEASE
	DETECT
EQ 1 (EQUALIZER 1) EQ 2 (EQUALIZER 2) EQ 3 (EQUALIZER 3) EQ 4 (EQUALIZER 4)	ON/OFF
	TYPE

Value (Category)	Value (Target)
EQ 1: PEQ (EQUALIZER 1 PARAMETRIC) EQ 2: PEQ (EQUALIZER 2 PARAMETRIC) EQ 3: PEQ (EQUALIZER 3 PARAMETRIC) EQ 4: PEQ (EQUALIZER 4 PARAMETRIC)	LO GAIN
	LM FREQ
	LM Q
	LM GAIN
	HM FREQ
	HM Q
	HM GAIN
	HI GAIN
	LEVEL
	LO CUT
	HI CUT
	EQ1: GEQ (EQUALIZER 1 GRAPHIC) EQ2: GEQ (EQUALIZER 2 GRAPHIC) EQ3: GEQ (EQUALIZER 3 GRAPHIC) EQ4: GEQ (EQUALIZER 4 GRAPHIC)
63Hz	
125Hz	
250Hz	
500Hz	
1kHz	
2kHz	
4kHz	
8kHz	
16kHz	
LEVEL	
DELAY 1 DELAY 2 DELAY 3 DELAY 4	ON/OFF
	TIME
	FEEDBACK
	HI CUT
MST DELY (MASTER DELAY)	E.LEVEL
	D.LEVEL
	ON/OFF
	TYPE
	TIME
	FEEDBACK
	HI CUT
	E.LEVEL
	D.LEVEL
	MOD RATE
	MOD DEPTH
	DUCK SENS
	DUCK PRE DPT
	DUCK POST DPT
TAP TIME	
TRIGGER	
LEVEL	
AUTO TRIG (AUTO TRIGGER)	
M.DL:TAPE (MASTER DELAY:TAPE)	HEAD
M.DL:SHMR (MASTER DELAY:SHIMMER)	PITCH
	PITCH BAL
	PITCH FBK
M.DL:DUAL (MASTER DELAY:DUAL)	MODE
	1:TYPE
	1:TIME
	1:FEEDBK (1:FEEDBACK)
	1:HI CUT (1:HIGH CUT)
	1:LEVEL (1:EFFECT LEVEL)
	2:TYPE
	2:TIME
	2:FEEDBK (2:FEEDBACK)
	2:HI CUT (2 HIGH CUT)
2:LEVEL (2:EFFECT LEVEL)	

Value (Category)	Value (Target)
M.DL:TWST (MASTER DELAY:TWIST)	MODE
	RISE TIME
	FALL TIME
	FADE TIME
M.DL:GLT (MASTER DELAY:CLITCH)	DUTY
M.DL:ECHO (MASTER DELAY:ECHO)	WOW&FLUT (WOW & FLUTTER)
	SP HEAD (SPACE HEAD)
	BIN HEAD (BINDRUM HEAD)
	SELECTOR
M.DL:SDE (MASTER DELAY:SDE-3000)	FIL (FILTER)
	TIME2 (TIMEx2)
	DL PH (DELAY PHASE)
	FB PH (FEEDBACK PHASE)
M.DL:DD20 (MASTER DELAY:DD-20)	TONE
CHORUS	ON/OFF
	TYPE
	RATE
	DEPTH
	PRE-DELY (PRE-DELAY)
	WAVEFORM
	E.LEVEL
	D.LEVEL
	LO CUT
	HI CUT
	CHO:DUAL (CHORUS:DUAL)
1:DEPTH	
1:PRE-DLY	
1:WAVE (1:WAVEFORM)	
1:LEVEL	
1:LO CUT	
1:HI CUT	
2:RATE	
2:DEPTH	
2:PRE-DLY	
2:WAVE (2:WAVEFORM)	
2:LEVEL	
2:LO CUT	
2:HI CUT	
OUTPUT (OUTPUT MODE)	
FX1	ON/OFF
FX2	
FX3	TYPE
1:ACG SIM (FX1:AC GUITAR SIM) 2:ACG SIM (FX2:AC GUITAR SIM) 3:ACG SIM (FX3:AC GUITAR SIM)	BODY
	LO
	HI
	LEVEL
1:AC RES (FX1:AC RESONANCE) 2:AC RES (FX2:AC RESONANCE) 3:AC RES (FX3:AC RESONANCE)	TYPE
	RESO (RESONANCE)
	TONE
	LEVEL
1:AUTO WH (FX1:AUTO WAH) 2:AUTO WH (FX2:AUTO WAH) 3:AUTO WH (FX3:AUTO WAH)	FILTER MODE
	RATE
	DEPTH
	FREQ (FREQUENCY)
	RESO (RESONANCE)
	WAVEFORM
	E.LEVEL
	DIR MIX

Value (Category)	Value (Target)
1:CHORUS (FX1:CHORUS) 2:CHORUS (FX2:CHORUS) 3:CHORUS (FX3:CHORUS)	TYPE
	RATE
	DEPTH
	PRE-DELY (PRE-DELAY)
	WAVEFORM
	E.LEVEL
	D.LEVEL
1:CH DUAL (FX1:CHORUS DUAL) 2:CH DUAL (FX2:CHORUS DUAL) 3:CH DUAL (FX3:CHORUS DUAL)	LO CUT
	HI CUT
	1:RATE
	1:DEPTH
	1:PRE-DL (1:PRE-DELAY)
	1:WAVE (1:WAVEFORM)
	1:LEVEL
1:CH PRIM (FX1:CHORUS PRIME) 2:CH PRIM (FX2:CHORUS PRIME) 3:CH PRIM (FX3:CHORUS PRIME)	1:LO CUT
	1:HI CUT
	2:RATE
	2:DEPTH
	2:PRE-DL (2:PRE-DELAY)
	2:WAVE (2:WAVEFORM)
	2:LEVEL
1:CHO CE1 (FX1:CHORUS CE-1) 2:CHO CE1 (FX2:CHORUS CE-1) 3:CHO CE1 (FX3:CHORUS CE-1)	2:LO CUT
	2:HI CUT
	SWEETNES (SWEETNESS)
1:CHO BS (FX1:CHORUS BASS) 2:CHO BS (FX2:CHORUS BASS) 3:CHO BS (FX3:CHORUS BASS)	BELL
	PREAMP (PREAMP SW)
	GAIN (PREAMP GAIN)
1:C-VIBE (FX1:CLASSIC-VIBE) 2:C-VIBE (FX2:CLASSIC-VIBE) 3:C-VIBE (FX3:CLASSIC-VIBE)	LEVEL (PREAMP LEVEL)
	TYPE
	RATE
	DEPTH
	E.LEVEL
1:COMP (FX1:COMPRESSOR) 2:COMP (FX2:COMPRESSOR) 3:COMP (FX3:COMPRESSOR)	LO CUT
	HI CUT
	MODE
	RATE
1:COMP BS (FX1:COMPRESSOR BASS) 2:COMP BS (FX2:COMPRESSOR BASS) 3:COMP BS (FX3:COMPRESSOR BASS)	DEPTH
	E.LEVEL
	LEVEL
	DIR MIX
1:DEFRET (FX1:DEFRETTER) 2:DEFRET (FX2:DEFRETTER) 3:DEFRET (FX3:DEFRETTER)	THRESHLD (THRESHOLD)
	SENS
	DEPTH
	ATTACK
	RESO (RESONANCE)
	TONE
	E.LEVEL
DIR MIX	

Value (Category)	Value (Target)
1:DEF BS (FX1:DEFRETTOR BASS) 2:DEF BS (FX2:DEFRETTOR BASS) 3:DEF BS (FX3:DEFRETTOR BASS)	SENS
	ATTACK
	TONE
	E.LEVEL
1:DIST (FX1:DISTORTION) 2:DIST (FX2:DISTORTION) 3:DIST (FX3:DISTORTION)	DIR MIX
	TYPE
	DRIVE
	TONE
	BOTTOM
	E.LEVEL
	DIR MIX
	SOLO SW
1:FEDBAK (FX1:FEEDBACKER) 2:FEDBAK (FX2:FEEDBACKER) 3:FEDBAK (FX3:FEEDBACKER)	SOLO LVL (SOLO LEVEL)
	MODE
	TRIGGER
	DEPTH
	RISE TIME
	OCT RISE (OCT RISE TIME)
	FEEDBACK
	OCT FBK (OCT FEEDBACK)
1:FLANGR (FX1:FLANGER) 2:FLANGR (FX2:FLANGER) 3:FLANGR (FX3:FLANGER) 1:FL BASS (FX1:FLANGER BASS) 2:FL BASS (FX2:FLANGER BASS) 3:FL BASS (FX3:FLANGER BASS)	VIB RATE
	VIB DEPT (VIB DEPTH)
	RATE
	DEPTH
	RESO (RESONANCE)
	MANUAL
	TURBO
	WAVEFORM
	STEP (STEP RATE)
	SEPARATE (SEPARATION)
	E.LEVEL
	LO DAMP
HI DAMP	
LO CUT	
HI CUT	
DIR MIX	
1:HARMO (FX1:HARMONIST) 2:HARMO (FX2:HARMONIST) 3:HARMO (FX3:HARMONIST)	VOICE
	1:HARMO (1:HARMONY)
	1:PRE-DL (1:PRE-DELAY)
	1:FEEDBK (1:FEEDBACK)
	1:LEVEL
	2:HARMO (2:HARMONY)
	2:PRE-DL (2:PRE-DELAY)
1:HUMAN (FX1:HUMANIZER) 2:HUMAN (FX2:HUMANIZER) 3:HUMAN (FX3:HUMANIZER)	2:LEVEL
	D.LEVEL
	MODE
	VOWEL1
	VOWEL2
	SENS
	RATE
	DEPTH
MANUAL	
1:MST.FX (FX1:MASTERING FX) 2:MST.FX (FX2:MASTERING FX) 3:MST.FX (FX3:MASTERING FX)	LEVEL
	TYPE
	DYNAMICS
	TONE
	NATURAL

Value (Category)	Value (Target)
1:OCTAVE (FX1:OCTAVE) 2:OCTAVE (FX2:OCTAVE) 3:OCTAVE (FX3:OCTAVE)	TYPE
	-2OCT
	-1OCT
	D.LEVEL
	RANGE
1:OC BASS (FX1:OCTAVE BASS) 2:OC BASS (FX2:OCTAVE BASS) 3:OC BASS (FX3:OCTAVE BASS)	OC.LEVEL (POLY OCTAVE LEVEL)
	2-Oct
	1-Oct
	D.LEVEL
1:OVRTON (FX1:OVERTONE) 2:OVRTON (FX2:OVERTONE) 3:OVRTON (FX3:OVERTONE)	LOWER (LOWER LEVEL)
	UPPER (UPPER LEVEL)
	UNISON (UNISON LEVEL)
	D.LEVEL
	DETUNE
	LO
1:PAN (FX1:PAN) 2:PAN (FX2:PAN) 3:PAN (FX3:PAN)	HI
	OUTPUT (OUTPUT MODE)
	RATE
	DEPTH
	WAVEFORM
1:PHASER (FX1:PHASER) 2:PHASER (FX2:PHASER) 3:PHASER (FX3:PHASER)	E.LEVEL
	DIR MIX
	TYPE
	STAGE
	RATE
	DEPTH
	RESO (RESONANCE)
	MANUAL
	LO DAMP
	HI DAMP
	LO CUT
	HI CUT
	BI-PHASE
	WAVEFORM
STEP (STEP RATE)	
SEPARATE (SEPARATION)	
1:P.SHIFT (FX1:PITCH SHIFT) 2:P.SHIFT (FX2:PITCH SHIFT) 3:P.SHIFT (FX3:PITCH SHIFT)	E.LEVEL
	DIR MIX
	VOICE
	1:PITCH
	1:FINE (1:PITCH FINE)
	1:FEEDBK (1:FEEDBACK)
	1:PRE-DL (1:PRE-DELAY)
1:LEVEL	
1:MODE	
2:PITCH	
2:FINE (2:PITCH FINE)	
2:PRE-DL (2:PRE-DELAY)	
2:LEVEL	
2:MODE	
2:MODE	
D.LEVEL	

Value (Category)	Value (Target)
1:RNG MOD (FX1:RING MOD) 2:RNG MOD (FX2:RING MOD) 3:RNG MOD (FX3:RING MOD)	INTELLI (INTELLIGENT)
	FREQ (FREQUENCY)
	MOD RATE (FREQUENCY MOD RATE)
	MOD DEPT (FREQUENCY MOD DEPTH)
	E.LEVEL
	DIR MIX
1:ROTARY (FX1:ROTARY) 2:ROTARY (FX2:ROTARY) 3:ROTARY (FX3:ROTARY)	SPEED (SPEED SELECT)
	SLOW (SLOW RATE)
	FAST (FAST RATE)
	RISE TIME
	FALL TIME
	MIC DIST (MIC DISTANCE)
	ROT/HORN (ROTOR/HORN BALANCE)
	DRIVE
	E.LEVEL
DIR MIX	
1:SITAR (FX1:SITAR SIM) 2:SITAR (FX2:SITAR SIM) 3:SITAR (FX3:SITAR SIM)	SENS
	DEPTH
	RESO
	BUZZ
	TONE
	E.LEVEL
	DIR MIX
1:SLICER (FX1:SLICER) 2:SLICER (FX2:SLICER) 3:SLICER (FX3:SLICER)	PATTERN
	RATE
	ATTACK
	DUTY
	TRIGGER
	E.LEVEL
1:SL GEAR (FX1:SLOW GEAR) 2:SL GEAR (FX2:SLOW GEAR) 3:SL GEAR (FX3:SLOW GEAR)	SENS
	RISE TIME
	LEVEL
1:SG BASS (FX1:SLOW GEAR BASS) 2:SG BASS (FX2:SLOW GEAR BASS) 3:SG BASS (FX3:SLOW GEAR BASS)	SENS
	RISE TIME
	LEVEL
1:S-HOLD (FX1:SOUND HOLD) 2:S-HOLD (FX2:SOUND HOLD) 3:S-HOLD (FX3:SOUND HOLD)	TRIGGER
	RISE TIME
	LEVEL
1:S-BEND (FX1:S-BEND) 2:S-BEND (FX2:S-BEND) 3:S-BEND (FX3:S-BEND)	TRIGGER
	PITCH
	RISE TIME
	FALL TIME
1:TCH WAH (FX1:TOUCH WAH) 2:TCH WAH (FX2:TOUCH WAH) 3:TCH WAH (FX3:TOUCH WAH)	FILTER (FILTER MODE)
	POLARITY
	SENS
	FREQ (FREQUENCY)
	RESO (RESONANCE)
	DECAY
	E.LEVEL
	DIR MIX

Value (Category)	Value (Target)
1:TW BASS (FX1:TOUCH WAH BASS) 2:TW BASS (FX2:TOUCH WAH BASS) 3:TW BASS (FX3:TOUCH WAH BASS)	FILTER (FILTER MODE)
	POLARITY
	SENS
	FREQ (FREQUENCY)
	RESO (RESONANCE)
	DECAY
	E.LEVEL
	DIR MIX
	RATE
1:TREM (FX1:TREMOLO) 2:TREM (FX2:TREMOLO) 3:TREM (FX3:TREMOLO)	DEPTH
	WAVEFORM
	TRIGGER
	RISE TIME
	E.LEVEL
	DIR MIX
1:VIBRAT (FX1:VIBRATO) 2:VIBRAT (FX2:VIBRATO) 3:VIBRAT (FX3:VIBRATO)	RATE
	DEPTH
	COLOR
	TRIGGER
	RISE TIME
	E.LEVEL
REVERB	DIR MIX
	ON/OFF
	TYPE
	TIME
	DENSITY
	PRE-DELY (PRE-DELAY)
	TONE
	E.LEVEL
	D.LEVEL
	LO CUT
	HI CUT
	LO DAMP
	HI DAMP
	MOD RATE
	MOD DEPT (MOD DEPTH)
DUCK SENS	
DUCK PRE (DUCK PRE DEPTH)	
DUCK PST (DUCK POST DEPTH)	
REV SHIMR (REVERB SHIMMER)	1:PITCH
	1:LEVEL
	2:PITCH
REV DUAL (REVERB DUAL)	2:LEVEL
	1:TYPE
	1:TIME
	1:PRE-DL (1:PRE-DELAY)
	1:DENSTY (1:DENSITY)
	1:TONE
	1:LEVEL
	1:LO CUT
	1:HI CUT
	2:TYPE
	2:TIME
	2:PRE-DL (2:PRE-DELAY)
	2:DENSTY (2:DENSITY)
	2:TONE
	2:LEVEL
2:LO CUT	
2:HI CUT	

Value (Category)	Value (Target)
REV TECO (REVERB TERA ECHO)	MODE
	SPREAD (SPREAD TIME)
	FEEDBACK
	TRIGGER
PEDAL FX	ON/OFF
	TYPE
	E.LEVEL
	DIR MIX
PDL BEND (PEDAL BEND)	PITCHMIN (PITCH MIN)
	PITCHMAX (PITCH MAX)
	PDL POS (PEDAL POSITION)
PDL WAH (PEDAL WAH)	WAH TYPE
	PDL POS (PEDAL POSITION)
	PDL MIN (PEDAL MIN)
	PDL MAX (PEDAL MAX)
FOOT VOL (FOOT VOLUME)	VOL MIN (VOLUME MIN)
	VOL MAX (VOLUME MAX)
	CURVE (VOLUME CURVE)
	PDL POS (PEDAL POSITION)
DIVIDER 1 DIVIDER 2 DIVIDER 3	MODE
	CHANNEL (CHANNEL SELECT)
	A:DYNAMC (A:DYNAMIC)
	A:SENS (A:DYNAMIC SENS)
	A:FILTER
	A:CUTOFF (A:CUTOFF FREQUENCY)
	B:DYNAMC (B:DYNAMIC)
	B:SENS (B:DYNAMIC SENS)
	B:FILTER
	B:CUTOFF (B:CUTOFF FREQUENCY)
MIXER 1 MIXER 2 MIXER 3	MODE
	A:LEVEL
	B:LEVEL
	A/B BAL (A/B BALANCE)
	SPREAD
	ST LINK (STEREO LINK)
SND/RET1 (SEND/RETURN 1) SND/RET2 (SEND/RETURN 2)	ON/OFF
	MODE
	SEND (SEND LEVEL)
	RETURN (RETURN LEVEL)
	ADJUST
LOOPER	PLAY LVL (PLAY LEVEL)
AMP CTL (AMP CONTROL)	AMP CTL 1
	AMP CTL 2
MASTER	PATCH LV (PATCH LEVEL)
	BPM
	KEY
	CARRYOVR (CARRYOVER)
	BS MODE (BASS MODE)
SUB OUT	LEVEL (OUTPUT LEVEL)
TUNER	ON
PATCH	PATCH (PATCH SELECT)
USB AUDIO	OUT MIXLV (OUTPUT MIX LEVEL)
	SUB MIXLV (SUB OUT MIX LEVEL)
OUT GEQ L (OUTPUT GLOBAL EQ L) *1	LO GAIN
OUT GEQ R (OUTPUT GLOBAL EQ R) *1	MID GAIN
SUB GEQ L (SUB OUT GLOBAL EQ L) *1	HI GAIN
SUB GEQ R (SUB OUT GLOBAL EQ R) *1	LEVEL

Value (Category)	Value (Target)
PREAMP *2	TYPE
	GAIN
	BASS
	MIDDLE
	TREBLE
TOTAL RV (TOTAL REVERB)	LEVEL
TOTAL NS (TOTAL NOISE SUPPRESSOR)	THRESHLD
INPUT	INPUT L
	INPUT R



*1 Operates as stereo if STEREO LINK is ON.

*2 Lets you control the AIRD PREAMP of the channel that is enabled by the divider. If multiple channels are enabled, AIRD PREAMP 1 takes priority.

Parameter	Value	Explanation
Knob Lock	OFF, ON	Specifies whether knob operations will be disabled. If this is ON, knob operations will be disabled.

* You can also press both the [EXIT] and [A] buttons together to disable knob operations. To enable, press the [EXIT] and [A] buttons together once more.

AMP CONTROL

Parameter	Value	Explanation
AMP CTL1 AMP CTL2	Specifies the operation of the AMP CTL 1, 2 jacks.	
	LATCH	Latch operation
	PULSE	Send a pulse when changing patches. PULSE 
	INVERT	INVERT 

* This is enabled when CTL 4, 5 SETTING is set to AMP CTL.

EXP HOLD

Parameter	Value	Explanation
EXP1 (EXP1 HOLD) EXP2 (EXP2 HOLD)	OFF	The operational status of the EXP PEDAL 1/2's FUNCTION (p. 33) is not carried over when patches are switched.
	ON	If the EXP PEDAL 1/2's FUNC (p. 33) are the same between 2 patches, the operational status is carried over when patches are switched. For example, if EXP PEDAL FUNCTION is set to FOOT VOLUME in both patches, the one before and the one after the change, the volume corresponding to the position the pedal is in (angle) at the time of the patch change will be maintained after the patch change. On the other hand, if the patch being changed to is set to WAH, the volume will be in accordance with the value set within the patch, and you'll obtain a wah effect that is in accordance with a value that reflects the current position (angle) of the pedal.

GROUND LIFT

Parameter	Value	Explanation
MAIN	In some cases, hum noise might occur if an amp or other effect unit is connected. If so, you might be able to reduce the noise by disconnecting the ground connector from the GT-1000CORE's chassis.	
	GND	The ground of the OUTPUT L, R jacks is connected to the chassis (no ground lift).
	LIFT	The ground of the OUTPUT jacks is disconnected from the chassis.
SUB	Specifies whether the ground of the SEND 1, 2 jacks and the RETURN 1, 2 jacks are connected to the GT-1000CORE's chassis or disconnected.	
	TYPE1	The ground of the SEND 1, 2 jacks and the RETURN 1, 2 jacks is connected to the chassis (no ground lift).
	TYPE2	The ground of the SEND 1 jack is disconnected from the chassis, and the ground of the RETURN 1, 2 jacks is connected to the chassis (no ground lift).
	TYPE3	The ground of the SEND 1, 2 jacks is connected to the chassis (no ground lift), and the ground of the RETURN 1, 2 jacks is disconnected from the chassis.

* When SEND1 SETTING and SEND2 SETTING are used as SEND and the sound doesn't seem right, change the SEND RETURN setting to TYPE 1.

OTHER

Parameter	Value	Explanation
LCD CONTRAST	Here you can adjust the brightness of the characters in the display.	
	1-10	Higher values increase the brightness.
SEND1 SETTING, SEND2 SETTING	This sets how the SEND and RETURN jacks are used.	
	SEND	The jacks are used as SEND and RETURN jacks. You can connect an external effects processor between the SEND jack and RETURN jack, and use it as one of the GT-1000CORE's effects processors.
	SUB OUT	The SEND jack is used as a SUB OUT jack. You can send a signal separate from the OUTPUT jack to a PA system or other equipment. In this case, the RETURN jack works as an AUX IN jack. The input signal is output from the OUTPUT jack along with the sound going through the GT-1000CORE effects. * Be aware that if a plug is not plugged into the RETURN jack, the signal sent to SUB OUT is also output to OUTPUT.
	SUB OUT, AUX MUTE	SUB OUT, AUX MUTE
CTL 4,5 SETTING	This sets how the CTL 4, 5/EXP 2 jack is used.	
	CTL IN	Operates as the CTL 4, 5/EXP 2 jack. You can control the various parameters by plugging in a footswitch or expression pedal.
	AMP CTL	Operates as the AMP CLT 1, 2 jack. If you connect this to the channel switch jack of a guitar amp, you can use the GT-1000CORE to switch channels.

* When SEND1 SETTING and SEND2 SETTING are used as SEND and the sound doesn't seem right, change the SEND RETURN setting to TYPE 1.

AUTO OFF

The power to this unit turns off automatically to save energy after a certain amount of time (20 minutes by default) has passed since it was last used or since its buttons or controls were operated.

- If the power automatically turns off, any unsaved data is lost. Before the power turns off, save the data that you want to keep.
- If you don't want the unit to turn off automatically, turn this setting off. Note that when the setting is turned off, the unit may consume more power.
- You can simply turn the power back on after it has turned off automatically.

Parameter	Value	Explanation
AUTO OFF	20MIN	The power will turn off automatically when 20 minutes have passed since you last played or operated the unit. * This is the factory setting.
	1HOUR	The power will turn off automatically when 1 hour has passed since you last played or operated the unit.
	5HOURS	The power will turn off automatically when 5 hours have passed since you last played or operated the unit.
	10HOURS	The power will turn off automatically when 10 hours have passed since you last played or operated the unit.
	OFF	The power will not turn off automatically.

FACTORY RESET

Initializes the GT-1000CORE to its factory-set condition.

Parameter	Value	Explanation
FROM, TO	SYSTEM	System parameter settings
	U001-U250	Settings for Patch Numbers U001-U250
	STOMPBOX	Settings for STOMPBOX

TUNER

Here you can make settings for the TUNER.

Memo

You can use the PAGE [◀] [▶] buttons to switch the tuner display.

Monophonic/polyphonic display



Monophonic display



Polyphonic display

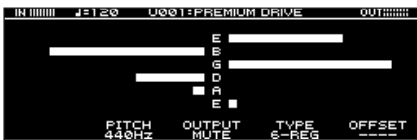

True Temperament display



* This is a tuning mode for guitars that use True Temperament.

Parameter	Value	Explanation
MODE (TUNER MODE)	NORMAL, STREAM	Specifies the meter display method for the monophonic tuner.
PITCH	435-445 Hz (default: 440 Hz)	Specifies the reference pitch.
OUTPUT	MUTE	Sound will not be output while tuning.
	BYPASS	While tuning, the sound of the guitar being input to the GT-1000CORE will be output without change. All effects will be off.
	THRU	Allows you to tune while hearing the current effect sound. * Only for monophonic tuner.
TYPE	6-REG (6-REGULAR), 6-DROP D, 7-REG (7-REGULAR), 7-DROP A, 4-B REG (4-B REGULAR), 5-B REG (5-B REGULAR)	Selects the type of tuning for the polyphonic tuner.

Parameter	Value	Explanation
OFFSET	-5--1, ---	Adjusts the reference pitch of the polyphonic tuner in semitone units relative to standard tuning.

METRONOME

Here you can make settings for the METRONOME.

- * You can select the output destination of the metronome sound.
- * By pressing knob 1 you can set the metronome's BPM to the master BPM value.

Parameter	Value	Explanation
BPM	20-250	Specifies the tempo.
BEAT	1/1-8/1, 1/2-8/2, 1/4-8/4, 1/8-8/8	Selects the time signature.
OFF/ON	OFF, ON	Turns the metronome on/off.
LEVEL	0-100	Adjusts the volume of the metronome sound.

Saving a Sound (WRITE)

Saving a Patch (PATCH WRITE)

When you want to save a patch you have created, save it as a user patch by following the procedure below. If you do not save the patch, the edited settings will be lost when you turn off the power or switch to another patch.

1. Press the [WRITE] button.



2. Press knob [1] to select "WRITE" (PATCH WRITE).



3. Use knob [1] to select the save-destination (U001–U250).

You can use knobs [3]–[5] and [SELECT] knob to edit the name.

Editing a name

To edit the patch name, use knob [SELECT] to move the cursor and use knob [5] to change the character.

Controller	Operation
Turn the [3] knob	Selects the type of characters
Press the [3] knob	Delete one character (delete)
Turn the [4] knob	Switch uppercase/lowercase
Press the [4] knob	Insert one space (insert)
Turn the [5] knob	Changes the character
Turn the [SELECT] knob	Moves the cursor

4. Press the [WRITE] button once again.



The patch is written.

Exchanging Patches (PATCH EXCHANGE)

On the GT-1000CORE, you can "swap" or exchange the positions of two User patches.

1. Select the exchange source patch.
2. Press the [WRITE] button.
3. Press knob [2] to select "EXCHANGE" (PATCH EXCHANGE).
4. Use knob [1] to select the other user patch that you want to exchange.

* If you decide to cancel without exchanging, press the [EXIT] button a several times. You'll be returned to the Play screen.



5. Press the [WRITE] button once again.

A confirmation message appears.



6. Press the [5] knob.



The patches will be exchanged. If you decide to cancel the exchange operation, press knob [4].

Initializing Patches (PATCH INITIALIZE)

You can return (initialize) a User patch to its original factory settings. This is convenient when you want to create a new patch from scratch.

NOTE

Any tone settings you've stored in a patch are lost once the initialization is executed.

1. Press the [WRITE] button.
2. Press knob [3] to select "INITIALIZE" (PATCH INITIALIZE).



3. Use knob [1] to select the user patch that you want to initialize.

* If you decide to cancel without initializing, press the [EXIT] button a several times. You'll be returned to the Play screen.

4. Press the [WRITE] button once again.

A confirmation message appears.



5. Press the [5] knob.



The patch will be initialized. If you decide to cancel the initialize operation, press knob [4].

Inserting a Patch (PATCH INSERT)

You can insert a patch into any position of the user patches.

For example, if you insert patch U001 at U002, patch U002 and subsequent patches are shifted (renumbered) backward by one. (Patch U002 becomes U003.)

NOTE

When you execute the insert operation, the last user patch (U250) is deleted.

1. Press the [WRITE] button.
2. Press knob [4] to select "INSERT" (PATCH INSERT).



3. Use knob [1] to select the insert-destination user patch.

* If you decide to cancel without inserting, press the [EXIT] button a several times. You'll be returned to the Play screen.

4. Press the [WRITE] button once again.

A confirmation message appears.



5. Press the [5] knob.

The patch is inserted at the specified position. If you decide to choose the insert operation, press knob [4].

